

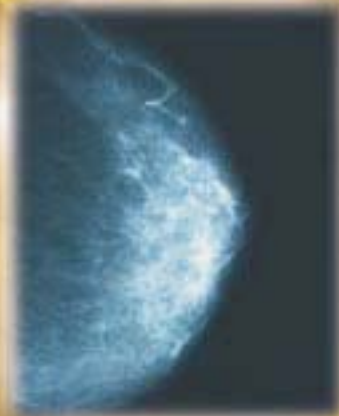

AMD TECHNOLOGIES X-RAY IMAGING PRODUCT CATALOG



800.423.3535
www.digitalams.com



TABLE OF CONTENTS

ILLUMINATORS

Illuminator Product Selector.....11

General Purpose Illuminators

Feature Summary.....4

VariVue™5

TrueVue™5

QuadVue™6

ClearVue3™5

RT-2™6

ShutterVue™6

Special Procedure Illuminators

14" x 36" SpineVue™7

14" x 51" OrthoVue™7

UltraVue™7

BriteSpot™ Illuminators10

Mammography Illuminators

MasterVue™9

MammoVue™9

Magnifying Glasses10

Technical Information & Products

Features11

Dimensions12-13

Luminescence Monitor10

MOTORIZED VIEWERS

Mammolux™13

Rotolux™14

RADIATION PROTECTION PRODUCTS

Aprons

Front Protection Aprons18

Special Procedure Aprons19

Dental Aprons20

Other Items

Blockers22

Eyewear5

Gloves22

Gonad / Ovarian Shields.....22

Lead Vinyl Sheeting.....22

Mobile Barriers21

Storage Racks21

DARKROOM PRODUCTS

Safelights.....25

Patient I.D. Printers.....26

Information Signs.....26

Film Safes.....26

Safe-T-Lock26

FILM & RECORDS STORAGE

NEW - CD/DVD Mailers & Filers.....27

Film Mailers & Filers27

NEW - CD/DVD & File Carriers.....27

NEW - Film Storage Boxes28

Wall Film & Records Holder.....28

IMPROVED - Stackable Cabinets.....28

X-Ray & Media Filing Cabinets.....29

Digital Support Carts30

OTHER ACCESSORIES

Patient Positioning Aids

Film Markers31

Sandbags.....32

Table Pads.....32

Patient Transfer Boards.....32

Patient Positioning Foam33-34

Body Calipers.....33

Patient Information Signs.....35

Cassette Holders & Transport Carts.....36

X-Ray Film.....37

Cassettes, Screens & Grids.....38

GO SHOPPING 

Go to www.digitalams.com



LEARN ABOUT DIGITAL IMAGING

AMD CAN SERVE YOUR DIGITAL, AS WELL AS YOUR FILM NEEDS

For more than 15 years the staff of AMD has been providing innovative PACS solutions to the radiology market. We target the office, clinic, imaging center markets with our innovative, all-in-one solutions. Our PACS products are designed to require minimal on-site IT support.

But PACS is more than hardware and software. It's really about service support. We focus on this for our dealers and their end-users. We think we exceed the mark as we service clients around the world.

Catella PACS now has over 350 installations in North America!

Our Full PACS Catalog

Solutions for Small and Mid-Sized Practices

Solutions for Mid-Sized and Large Practices

Digital Displays for the OR and ER

Our Extensive PACS Furniture Collection

800.423.3535
www.digitalams.com



LEARN ABOUT DIGITAL IMAGING

AMD'S PACS-in-a-BOX is a great solution for small to mid-sized practices.

AMD's "PACS-in-a-BOX" products are a combination of hardware and software. Each one is a complete PACS solution. Each is designed to handle the needs of physician offices, clinics and imaging groups which have one to five imaging modalities (for example, X-ray, CR, DR, Ultrasound, CT or MR).

Assuming that there is limited IT expertise at facilities of this size, AMD has simplified its installation and training protocol to as little as one day. Ongoing support is handled remotely via the Internet. "PACS-in-a-BOX" solutions can be interconnected to electronic medical records systems ("EMR") and/or scheduling and billing systems.



PACS-1M is a true single modality PACS and image display solution. PACS (Picture Archive and Communication System) is the universal medical term for digital imaging networks and equipment. It is based on DICOM, an international standard. If you select solutions that use this standard, you are not locked into one vendor's solution as your practice grows.



- PACS-1M includes:**
- Diagnostic Workstation Software (Pro)
 - 20.4" 2 Megapixel Color LCD Monitor
 - Single Modality Input
 - Image Relay Software
 - 500GB Hard Drive¹
 - Catella Archive Software
 - DICOM Importer Software
 - USB External HD Backup
 - One-click CD creation
 - 1 year hardware/software warranty

PACS-3M includes:

- Diagnostic Workstation Software (Elite)
- 20.4" 2 Megapixel Color LCD Monitor
- Three Modality Input
- Image Gateway Software
- 1TB Hard Drive Space¹
- Catella Archive Software
- Image Stitching Software
- DICOM Importer Software
- External USB HD Backup
- External CD burner/labeler
- 3 Clinical Review Software Licenses
- 1 year hardware/software warranty



PACS-3M doubles the archive capacity of the "1M" model and takes input from up to three modalities. MPR is a standard feature. In addition, PACS-3M has a CD burner and labeler that adds an important professionalism to your communications. Finally, this package includes three Clinical Review (LAN) software licenses to provide "electronic viewboxes" in key areas of your clinic, such as patient exam rooms. Additional Clinical Review licenses can be added as needed. (Clinical Review software supports screen resolutions of 1280x1024, 1680x1050, 1440x900 & 1360x768).

NOW WITH WIDE-SCREEN SUPPORT!



PACS-5M uses a more advanced and faster processor to handle the significantly greater workload we would expect to find in the busiest physician offices and clinics. It will store the equivalent of several hundred thousand films.¹ PACS-5M takes input from up to five modalities and comes with a robotic CD burner/labeler to save valuable office time. Our Web Server software is included as well as 5 Clinical Review licenses that can be used at either internal or remote locations. No separate Web Server is required! Add more Clinical Review software licenses as needed. (Clinical Review software supports screen resolutions of 1280x1024, 1680x1050, 1440x900 & 1360x768).



- PACS-5M includes:**
- Diagnostic Workstation Software (Elite)
 - 20.4" 2 Megapixel Color LCD Monitor
 - Five Modality Input
 - Image Gateway Software
 - 2TB Hard Drive space¹
 - Catella Archive Software
 - 5 Clinical Review software licenses for LAN or WEB
 - Image Stitching Software
 - DICOM Importer Software
 - WebServer Software
 - External USB HD Backup
 - Auto/Robotic-CD burner/labeler
 - 1 year hardware/software warranty

¹-Exact number is dependent on size of files created by your modality.

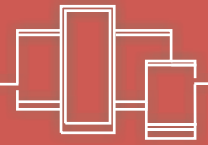

X - R A Y I L L U M I N A T O R S

General Purpose Illuminators

RT-2™

Offers all the standard features plus instant-on switching, availability in over 50 models and a wide assortment of options.

ClearVue3™

Includes all the features of the RT-2 plus three bulbs for greater luminescence, more homogeneous lighting.

QuadVue™

Designed for selected high-bright applications, the QuadVue offers illuminator with four bulbs.

VariVue™

Includes all the features of the ClearVue3 plus standard film activated switches, and standard two-level lighting.

TrueVue™

Using the same advanced lighting used for backlighting LCD displays, the TrueVue provides a luminance of 3500 cd/m² and a uniformity greater than 90%. All this in a 1.5" thin product.

ShutterVue™

For the best viewing conditions. Standard features include masking, variable lighting, exceptional homogenous lighting.

Special Procedure Models

Whether you need a 14" x36", 14" x 51" or 12" x 24" viewbox, AMD can provide it. We offer many of these model in up to "4-bank" sizes.

Mammography Illuminators

MasterVue™

Engineered for full ACR and MQSA compliance for mammography at an affordable cost, the shutter-equipped MasterVue exceeds the required luminescence levels, provides adjustable light intensity, full film masking and more.

MammoVue™

Designed specifically for mammography, the MammoVue is an economical illuminator designed for small format films, providing compliance orientation without the need for shutters.



800.423.3535

www.digitalams.com

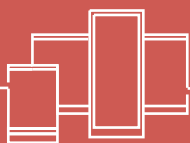

VARIVUE™ ILLUMINATORS

Truly the best viewing system for radiographic diagnostic work, the VariVue illuminator provides over 3,500 cd/m² of luminescence in a three bulb design. Its unique design incorporates two-level lighting with our advanced reflector system to provide full control of the reading environment.



VariVue Series

TRUEVUE™ ILLUMINATORS

The TrueVue employs the most advanced lamps used for backlighting in LCD displays. There are many advantages, including 2 ½ times longer life expectancy, light uniformity greater than 90% and flicker-free viewing to help minimize eye strain.

Available in one-tier, wallmounted/free standing configurations. One-, two-, three-, and four-bank models.



TrueVue Series

Model	Height	Width	Depth	ASW
<i>With Film Activated Switches and Variable Lighting</i>				
601D	19.375" (49.2 cm)	21.25" (54.0 cm)	1.5" (3.9 cm)	7.3 lbs (3.3 kgs)
602D	19.375" (49.2 cm)	35.25" (89.5 cm)	1.5" (3.9 cm)	12.1 lbs (5.5 kgs)
603D	19.375" (49.2 cm)	49.25" (125.1 cm)	1.5" (3.9 cm)	20.7 lbs (9.4 kgs)
604D	19.375" (49.2 cm)	63.25" (160.6 cm)	1.5" (3.9 cm)	26.6 lbs (12.1 kgs)
<i>Standard On/Off Switch</i>				
601E	19.375" (49.2 cm)	21.25" (54.0 cm)	1.5" (3.9 cm)	7.3 lbs (3.3 kgs)
602E	19.375" (49.2 cm)	35.25" (89.5 cm)	1.5" (3.9 cm)	12.1 lbs (5.5 kgs)
603E	19.375" (49.2 cm)	49.25" (125.1 cm)	1.5" (3.9 cm)	20.7 lbs (9.4 kgs)
604E	19.375" (49.2 cm)	63.25" (160.6 cm)	1.5" (3.9 cm)	26.6 lbs (12.1 kgs)

CLEARVUE 3™ ILLUMINATORS

To provide superior critical lighting conditions for outstanding diagnostic work, the ClearVue 3 comes standard with three lamps that help eliminate hot spots and dark shadows.

Available in one-tier two-tier, wallmounted/free standing, recessed and consolemount configurations.



ClearVue 3 Series

For a listing of all models, dimensions, features and weights see pages 11-13.

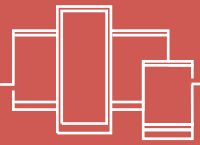

QuadVue Series

QUADVUE™ ILLUMINATORS

Certain “high-bright” applications require four lamps, and the QuadVue from AMS offers this feature along with excellent homogeneity of the lighting surface.

RT2™ ILLUMINATORS

Available in over 50 sizes and configurations, the RT-2 has a rapid start, two-lamp design. Wall-mount, recessed, mobilemount and consolemount designs can be ordered. Continuous film grips on the top and bottom of each viewing area hold your film firmly in place. Cluster switching on all multi-tier units.



RT2 Series

SHUTTERVUE™ ILLUMINATORS

These general purpose radiographic illuminators are equipped with shutters and variable light control to obtain the maximum diagnostic information from your films. They use a 4-way manual shutter system to eliminate extraneous light and help you focus on image detail. Equally important, ShutterVue illuminators have exceptionally even lighting across their entire viewing areas.

Model 108008
Two-Bank



Model 108004
One-Bank

These photos dramatically demonstrate how variable light control and masking of extraneous light increase the ability to visualize subtle pathologies.

Top: Without masking and at mid-range lighting.



Bottom: With masking and lighting adjusted to match film density. Notice the increased level of detail easily seen in the film.



SHUTTERVUE™

Model	Height	Width	Depth
108004	29" (72.2 cm)	29" (72.2 cm)	4-1/8" (10.4 cm)
108008	29" (72.2 cm)	41-7/8" (102.8 cm)	4-1/8" (10.4 cm)
108016	29" (72.2 cm)	53-3/8" (133.4 cm)	4-1/8" (10.4 cm)
108020	29" (72.2 cm)	71-3/4" (179.0 cm)	4-1/8" (10.4 cm)
108024	53-3/8" (133.4 cm)	29" (72.2 cm)	4-1/8" (10.4 cm)

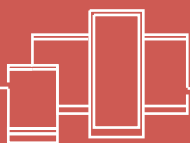

14" x 36" SPINEVUE™ ILLUMINATORS



Available in 8 configurations, our 14" x 36" format illuminators are ideal for orthopedic and spine films. Four film clips spaced along the sides can be used for securing smaller films. Internal sectional dividers produce sharp demarcation between each viewing area.

SPINEVUE™

Model	Height	Width	Depth	ASW
<i>Wallmount Models</i>				
501SSF	38.375" (97.5 cm)	15.625" (39.7 cm)	5.625" (14.3 cm)	36 lbs (16.4 kgs)
502SSF	38.375" (97.5 cm)	29.625" (75.2 cm)	5.625" (14.3 cm)	65 lbs (29.5 kgs)
503SSF	38.375" (97.5 cm)	43.625" (110.8 cm)	5.625" (14.3 cm)	120 lbs (54.5 kgs)
504SSF	38.375" (97.5 cm)	57.625" (146.4 cm)	5.625" (14.3 cm)	155 lbs (70.5 kgs)
<i>Recessed Models*</i>				
501SSF-R	38.375" (97.5 cm)	15.875" (40.3 cm)	5.625" (14.3 cm)	40 lbs (18.2 kgs)
502SSF-R	38.375" (97.5 cm)	29.875" (75.8 cm)	5.625" (14.3 cm)	69 lbs (31.4 kgs)
503SSF-R	38.375" (97.5 cm)	43.875" (111.4 cm)	5.625" (14.3 cm)	125 lbs (56.8 kgs)
504SSF-R	38.375" (97.5 cm)	57.875" (147.0 cm)	5.625" (14.3 cm)	160 lbs (72.7 kgs)

ORTHOVUE™ ILLUMINATORS

The OrthoVue is designed specially for hip and knee replacement planning for the orthopedic surgeon. These illuminators display 14" x 51" images. Our ability to make such a large standard product has led to special orders for other specialty applications.

ORTHOVUE™

Model	Height	Width	Depth	ASW
<i>Wallmount Models</i>				
201OV	60.5" (153.7 cm)	16.375" (41.6 cm)	5.75" (14.6 cm)	95 lbs (43.2 kgs)
202OV	60.5" (153.7 cm)	30.375" (77.2 cm)	5.75" (14.6 cm)	160 lbs (72.7 kgs)
203OV	60.5" (153.7 cm)	44.375" (112.7 cm)	5.75" (14.6 cm)	240 lbs (109.1 kgs)
204OV	60.5" (153.7 cm)	58.375" (148.3 cm)	5.75" (14.6 cm)	320 lbs (145.5 kgs)
<i>Recessed Models*</i>				
201OV-R	60.75" (154.3 cm)	16.625" (42.2 cm)	5.75" (14.6 cm)	95 lbs (43.2 kgs)
202OV-R	60.75" (154.3 cm)	30.625" (77.8 cm)	5.75" (14.6 cm)	160 lbs (72.7 kgs)
203OV-R	60.75" (154.3 cm)	44.625" (113.3 cm)	5.75" (14.6 cm)	240 lbs (109.1 kgs)
204OV-R	60.75" (154.3 cm)	58.625" (148.6 cm)	5.75" (14.6 cm)	320 lbs (145.5 kgs)

Model 201OV
One-Bank



ULTRAVUE™ ILLUMINATORS

Ultrasound, Dental and Industrial Illuminators.

The UltraVue illuminator is perfect for viewing smaller film formats. These include 18 x 24 cm, 24 x 30 cm, 8" x 10" and 10" x 12" sizes. All fit comfortably on this unit. Both wallmount and recessed models are available.



Model 541D

ULTRAVUE™

Model	Height	Width	Depth	ASW
541D	13.5" (34.3 cm)	24.625" (62.5 cm)	5.25" (13.3 cm)	25 lbs (11.4 kgs)
541R*	13.75" (34.9 cm)	24.875" (63.1 cm)	5.25" (13.3 cm)	26 lbs (11.8 kgs)

*Rough-in dimensions listed for recessed models

 Order larger models in any style, and have us help you with layouts and bids.

How We Customize: Simple as 1-2-3

- Step 1:** You provide a rough sketch of your product.
- Step 2:** Our designers interpret your request and create an engineering drawing.
- Step 3:** We produce the finished product.

All we need is your imagination.



MOBILEMOUNT™

With the MobileMount, the selected illuminator can be used in operating rooms, emergency rooms, classrooms, and other teaching environments. Available with RT-2, ClearVue3, QuadVue and VariVue models.

RECESSED MODELS

RT-2, ClearVue3, QuadVue and VariVue models are all available in recessed configurations.



Recessed



CONSOLEMOUNT™ MODELS

Many radiologists prefer angled viewing surfaces to help reduce eye fatigue. AMD offers both single and double-tiered units. Select either 20° or 35° bottom angles. Available on RT-2, ClearVue3, QuadVue and VariVue.

CONFIGURATIONS AVAILABLE

One-Tier Models

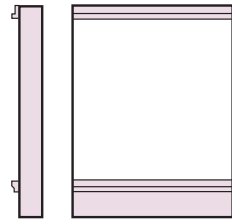

Two-Tier Models

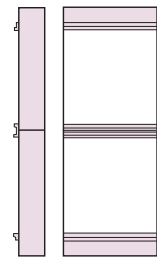

MobileMount™ Models

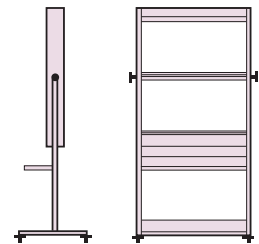

Recessed Models

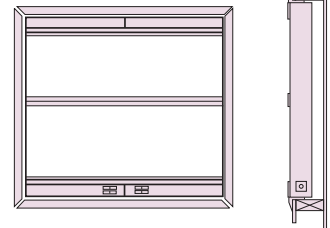

Consolemount™ Models

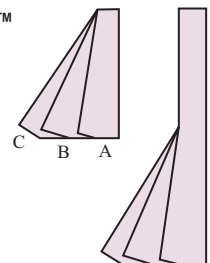

Angle B: 20°
Angle C: 35°

For a listing of all models, dimensions, features and weights see pages 11-13.

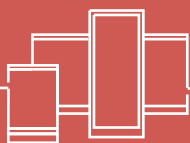

MASTERVUE™ ILLUMINATORS

Engineered for full ACR and MQSA compliance for mammography at an affordable cost, the shuttered MasterVue exceeds the required luminescence levels, provides adjustable light intensity, full film masking, and has an exceptional homogeneous light source and viewing surface. MasterVue provides sharp masking of films and eliminates distracting glare. The MasterVue accommodates both 18 x 24 cm and 24 x 30 cm films in a four-over-four format.

- Sharp masking of films
- Eliminates distracting glare
- Variable luminescence 1,700-7,000 cd/m²
- Exceptionally even intensity across the entire viewing area



Model 108000

MASTERVUE™

Model	Height	Width	Depth	ASW
108000	23.625" (60.0 cm)	42.5" (108.0cm)	4" (10.2 cm)	150 lbs (68.2 kgs)



Model 422CM

MAMMOVUE™ ILLUMINATORS

Designed specifically for mammography, the MammoVue is an economical illuminator specifically designed for small format films, providing compliance orientation without the need for shutters.

MASTERVUE™

Wallmounted	Recessed*	Consolemount**	Height	Width	Depth	ASW
18x24cm films						
302D	302R	302CM	16" (40.6 cm)	15.1" (38.4 cm)	5.125" (13.0 cm)	34 lbs (15.5 kgs)
304D	304R	304CM	16" (40.6 cm)	29.3" (74.4 cm)	5.125" (13.0 cm)	68 lbs (30.9 kgs)
322D	322R	322CM	32" (81.2 cm)	15.1" (38.4 cm)	5.125" (13.0 cm)	68 lbs (30.9 kgs)
324D	324R	324CM	32" (81.2 cm)	29.3" (74.4 cm)	5.125" (13.0 cm)	136 lbs (61.8 kgs)
24X30cm films						
402D	402R	402CM	16" (40.6 cm)	19.875" (50.5 cm)	5.125" (13.0 cm)	42 lbs (19.1 kgs)
404D	404R	404CM	16" (40.6 cm)	38.75" (98.4 cm)	5.125" (13.0 cm)	84 lbs (38.2 kgs)
422D	422R	422CM	32" (81.2 cm)	19.875" (50.5 cm)	5.125" (13.0 cm)	84 lbs (38.2 kgs)
424D	424R	424CM	32" (81.2 cm)	38.75" (98.4 cm)	5.125" (13.0 cm)	168 lbs (76.4 kgs)

*Rough-in dimensions for recessed units are .25" larger than the height and width measurements listed here.

**Weight of consolemounts are approximately 10 lbs more. Height dimensions vary with degree of bottom tier angle.

For a listing of all models, dimensions, features and weights see pages 11-13.

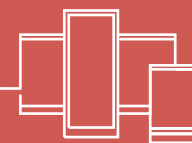

HIGH INTENSITY BRITESPOT™ ILLUMINATORS

AMD BriteSpot illuminators are available with a freestanding adjustable base or in a wall mounted configuration. Each has a foot pedal light switch.



Model 300FT

BRITESPOT™

Model	Type	Height	Width	Depth	ASW
300FT	Deskmount	10" (25.4 cm)	4.5" (11.4 cm)	7" (17.8 cm)	10 lbs (4.5 kgs)
300WM	Wallmount	10" (25.4 cm)	4.5" (11.4 cm)	7" (17.8 cm)	10 lbs (4.5 kgs)

CANDELALUX™ LUMINESCENCE MONITOR

The Candelalux represents the latest light meter technology. It has a state-of-the-art design and a very sensitive lens to provide quick and accurate readings from a digital display. It reads both luminescence (cd/m²) and illuminance (lux).



Model 40600
ASW=2 lbs. (.9kg)

AMD MAGNIFYING GLASSES

These magnifiers offer the highest quality optics needed for critical diagnosis. The model 107002 (2X) allows for films to be viewed using both eyes. Model 107006 (6X) is an economical lightweight model and the powerful 107012 (12X) features a new design that eliminates traditional "edge distortion". AMD magnifying glasses can be ordered with an optional mounting bracket and chain.



ASW= 2 lbs (.9kg)

ASW= Approximate Shipping Weight

	RT-2	ClearVue3	QuadVue	VariVue	TrueVue	ShutterVue	Special Procedure	MammoVue	MasterVue
Frame Construction	Steel	Steel	Steel	Steel	Alum/PEM	Steel	Steel	Steel	Steel
Finish	Pow der Coat	Pow der Coat	Pow der Coat	Pow der Coat	Plastic	Pow der Coat	Pow der Coat	Pow der Coat	Pow der Coat
Film Grip	Top-Gravity	Top-Gravity	Top-Gravity	Top-Gravity	Roller Bar	T/B - Friction	Top-Gravity	Top-Gravity	All Sides -Friction
Standard No. of Lamps	2	3	4	3	18	5	2	4	10
Depth	3.375"	3.375"	3.375"	3.375"	1.5"	4"	5.625	3.375"	4"
Slide-A-Way Viewing Panels	Yes	Yes	Yes	Yes				Yes	
Two-Level Lighting		O	O	S	Variable	O			Variable
Rapid Start Ballasts	Yes	Yes	Yes	Yes	Electronic	Electronic	Yes	Yes	Electronic
Luminance	2,300	3,400	3,850	3,500	3,500	1,700-5,000	2,200	4,200	1,700-7,400
Amps/viewing area	0.68	0.66	1.50	0.66		2.00	By Model	1.5	2.6
Watts/viewing area	30	45	60	30	55	100-290	60-95	60-160	360
VIEWING AREA SIZES									
14" x 17"	A	A	A	A	A	A			A
8" x 10" / 18 x 24 cm								A	A
10" x 12" / 24 x 30 cm								A	A
14" x 36"							A		
14" x 51"							A		
OPTIONS									
Film Activated Switch	A	A	A	A	A		A	A	
Master Switch	A	A	A	A			A	A	
Hospital Grade Power Cords	A	A	A	A		A	A	A	A
Upgrade to 3 lamps	A								
Upgrade to 4 lamps		A							
Special Voltage/Export Models	A	A	A	A		A	A	A	A
CONFIGURATIONS									
Wall-Mounted	A	A	A	A	A	A	A	A	A
Recessed	A	A	A	A		A	A	A	A
Two-Tier Units	A	A	A	A					
Consolemount Units	A	A	A	A					
DOCUMENTS									
Specification and Drawings	A	A	A	A	A	A	A	A	A
Product Literature	A	A	A	A	A	A	A	A	A

Notes:
 1 - VariVue units have film activated switches which must be protected when sliding out viewing panels.
 2 - Measurements made with standard light configurations. Additional lamps will increase these ratings dramatically.

ELECTRICAL
 POWER INPUT: 120V, 60 Hz (other voltages available.)
 LINE CORD: 6' (183 cm), 3-prong polarized plug. Generally, cords exit lower portion of right side of illuminators. Alternative locations can be specified.
 POWER CONNECTION - RECESSED UNITS: Knock out hole located on lower rear right corner.
 SPECIFICATION SHEETS: Available upon request or at www.digitalams.com.

CONSTRUCTION: Steel fabricated housings secured by spot welding. Viewing Panel is 1/8" thick, shatter resistant, translucent white cast acrylic. TrueVue models are use molded plastic housing.
MOBILEMOUNT: Stand is made of 16 gauge steel tubing with two 18 gauge 12" deep shelves. Four 3" wheels; front two wheels lock. Finished in hospital white powder coat paint.
SWITCHES: Standard location is bottom center, clustered for steel fabricated units. Rocker style, one or two-pole two or three position switches are used. Variable light controls use a rotary switch with a positive on/off click control. Standard location for ShutterVue and MasterVue is bottom left.

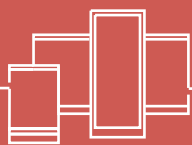

GENERAL PURPOSE ILLUMINATORS

DIMENSIONS

ONE-TIER ILLUMINATORS WALL MOUNTED - FREE STANDING MODELS

SERIES					DIMENSIONS			WEIGHT
TYPE	RT-2	CLEARVUE3	VARIVU	QUADVUE	Height	Width	Depth	ASW
One-Bank	501D	701D	E3	901D	21" (53.3 cm)	14" (35.6 cm)	3.375" (8.6 cm)	23 lbs. (10.5 kgs)
Two-Bank	502D	702D	801D	902D	21" (53.3 cm)	28" (71.1 cm)	3.375" (8.6 cm)	46 lbs. (21.0 kgs)
Three-Bank	503D	703D	802D	903D	21" (53.3 cm)	42" (106.7 cm)	3.375" (8.6 cm)	69 lbs. (31.5 kgs)
Four-Bank	504D	704D	803D	904D	21" (53.3 cm)	56" (142.2 cm)	3.375" (8.6 cm)	90 lbs. (40.9 kgs)
Five-Bank	505D	705D	804D	905D	21" (53.3 cm)	70" (177.8 cm)	3.375" (8.6 cm)	113 lbs. (51.4 kgs)
Six-Bank	506D	706D	805D	906D	21" (53.3 cm)	84" (213.4 cm)	3.375" (8.6 cm)	136 lbs. (61.8 kgs)

MOBILEMOUNT MODELS

SERIES					DIMENSIONS
TYPE	RT-2	CLEARVUE3	VARIVUE3	QUADVUE	Width
One-Bank	501MM	701MM	801MM	901MM	19" (48.3 cm)
Two-Bank	502MM	702MM	802MM	902MM	33" (83.8 cm)
Three-Bank	503MM	703MM	803MM	903MM	47" (119.4 cm)
Four-Bank	5024M	704MM	804MM	904MM	61" (154.9 cm)

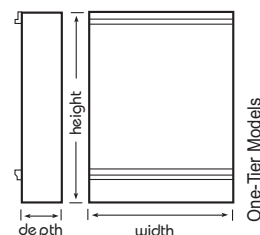

TWO-TIER ILLUMINATORS WALL MOUNTED - FREE STANDING MODELS

SERIES					DIMENSIONS			WEIGHT
TYPE	RT-2	CLEARVUE3	VARIVUE3	QUADVUE	Height	Width	Depth	ASW
One-over-One	521D	721D	821D	921D	42" (106.6 cm)	14" (35.6 cm)	3.375" (8.6 cm)	46 lbs. (21.0 kgs)
Two-over-Two	522D	722D	822D	922D	42" (106.6 cm)	28" (71.1 cm)	3.375" (8.6 cm)	92 lbs. (42.0 kgs)
Three-over-Three	523D	723D	823D	923D	42" (106.6 cm)	42" (106.7 cm)	3.375" (8.6 cm)	138 lbs. (63.0 kgs)
Four-over-Four	524D	724D	824D	924D	42" (106.6 cm)	56" (142.2 cm)	3.375" (8.6 cm)	180 lbs. (81.8 kgs)
Five-over-Five	525D	725D	825D	925D	42" (106.6 cm)	70" (177.8 cm)	3.375" (8.6 cm)	226 lbs. (102.8 kgs)
Six-over-Six	526D	726D	826D	926D	42" (106.6 cm)	84" (213.4 cm)	3.375" (8.6 cm)	272 lbs. (123.6 kgs)

MOBILEMOUNT MODELS

SERIES					DIMENSIONS
TYPE	RT-2	CLEARVUE3	VARIVUE3	QUADVUE	Width
One-over-One	521MM	721MM	821MM	921MM	19" (48.3 cm)
Two-over-Two	522MM	722MM	822MM	922MM	33" (83.8 cm)
Three-over-Three	523MM	723MM	823MM	923MM	47" (119.4 cm)
Four-over-Four	524MM	724MM	824MM	924MM	61" (154.9 cm)

Mobilemount Models:
Construction: 16 gauge steel tubing with two 18 gauge 12" deep shelves. Four 3" easy-glide wheels; front two wheels lock.
Finish: Hospital white powder coat paint.

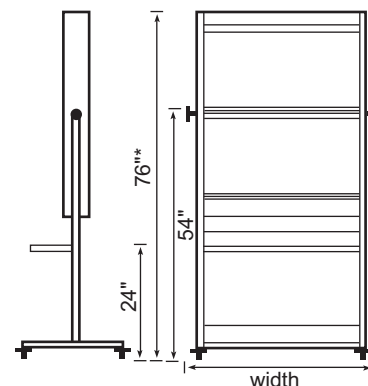

ConsoleMount Models

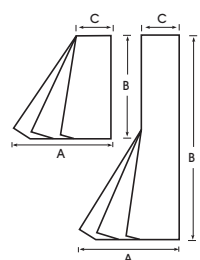

Two-Tier Models

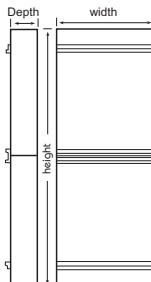

Recessed Models

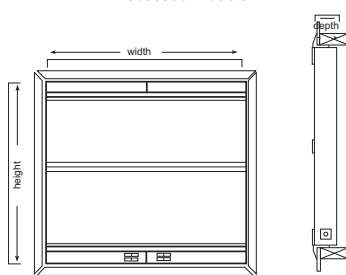

*One tier - 65"



DIMENSIONS

ONE-TIER ILLUMINATORS

RECESSED (See notes regarding installation on page 12.)

SERIES					DIMENSIONS (Suggested Rough-In Measurements)			WEIGHT	
	TYPE	RT-2	CLEARVUE3	VARIVUE	QUADVUE	Height	Width	Depth	ASW
One-Bank	501R	701R		801R	901R	21.25" (53.9 cm)	14.25" (36.2 cm)	3.375" (8.6 cm)	23 lbs. (10.5 kgs)
Two-Bank	502R	702R		802R	902R	21.25" (53.9 cm)	28.25" (71.7 cm)	3.375" (8.6 cm)	46 lbs. (21.0 kgs)
Three-Bank	503R	703R		803R	903R	21.25" (53.9 cm)	42.25" (107.4 cm)	3.375" (8.6 cm)	69 lbs. (31.5 kgs)
Four-Bank	504R	704R		804R	904R	21.25" (53.9 cm)	56.25" (142.9 cm)	3.375" (8.6 cm)	90 lbs. (40.9 kgs)
Five-Bank	505R	705R		805R	905R	21.25" (53.9 cm)	70.25" (178.4 cm)	3.375" (8.6 cm)	113 lbs. (51.4 kgs)
Six-Bank	506R	706R		806R	906R	21.25" (53.93)	84.25" (214.0 cm)	3.375" (8.6 cm)	136 lbs. (61.8 kgs)

CONSOLEMOUNT MODELS (Specify 20° or 35° angles.)

SERIES					DIMENSIONS (Suggested Rough-In Measurements)		WEIGHT	
	TYPE	RT-2	CLEARVUE3	VARIVUE	QUADVUE	ASW	Width	Height and Depth
One-Bank	501CM	701CM		801CM	901CM	23 lbs. (10.5 kgs)	14.25" (36.2 cm)	Varies as to angle selected
Two-Bank	502CM	702CM		802CM	902CM	46 lbs. (21.0 kgs)	28.25" (71.7 cm)	
Three-Bank	503CM	703CM		803CM	903CM	69 lbs. (31.5 kgs)	42.25" (107.4 cm)	
Four-Bank	504CM	704CM		804CM	904CM	90 lbs. (40.9 kgs)	56.25" (142.9 cm)	
Five-Bank	505CM	705CM		805CM	905CM	113 lbs. (51.4 kgs)	70.25" (178.4 cm)	
Six-Bank	506CM	706CM		806CM	906CM	136 lbs. (61.8 kgs)	84.25" (214.0 cm)	

TWO-TIER ILLUMINATORS

RECESSED (See notes regarding installation on page 12.)

SERIES					DIMENSIONS (Suggested Rough-In Measurements)			WEIGHT	
	TYPE	RT-2	CLEARVUE3	VARIVUE	QUADVUE	Height	Width	Depth	ASW
One-over-One	521R	721R		821R	921R	42.25" (107.3 cm)	14.25" (36.2 cm)	3.375" (8.6 cm)	46 lbs. (21.0 kgs)
Two-over-Two	522R	722R		822R	922R	42.25" (107.3 cm)	28.25" (71.7 cm)	3.375" (8.6 cm)	92 lbs. (42.0 kgs)
Three-over	523R	723R		823R	923R	42.25" (107.3 cm)	42.25" (107.4 cm)	3.375" (8.6 cm)	138 lbs. (63.0 kgs)
Four-over-Four	524R	724R		824R	924R	42.25" (107.3 cm)	56.25" (142.9 cm)	3.375" (8.6 cm)	180 lbs. (81.8 kgs)
Five-over-Five	525R	725R		825R	925R	42.25" (107.3 cm)	70.25" (178.4 cm)	3.375" (8.6 cm)	226 lbs. (102.8 kgs)
Six-over-Six	526R	726R		826R	926D	42.25" (107.3 cm)	84.25" (214.0 cm)	3.375" (8.6 cm)	272 lbs. (123.6 kgs)

CONSOLEMOUNT MODELS (Specify 20° or 35° angles.)

SERIES					DIMENSIONS (Suggested Rough-In Measurements)		WEIGHT	
	TYPE	RT-2	CLEARVUE3	VARIVUE	QUADVUE	ASW	Width	Height and Depth
One-over-One	521CM	721CM		821CM	921CM	56 lbs. (25.5 kgs)	14.25" (36.2 cm)	Varies as to angle selected
Two-over-Two	522CM	722CM		822CM	922CM	102 lbs. (46.5 kgs)	28.25" (71.7 cm)	
Three-over	523CM	723CM		823CM	923CM	148 lbs. (67.5 kgs)	42.25" (107.4 cm)	
Four-over-Four	524CM	724CM		824CM	924CM	190 lbs. (86.3 kgs)	56.25" (142.9 cm)	
Five-over-Five	525CM	725CM		825CM	925CM	236 lbs. (107.3 kgs)	70.25" (178.4 cm)	
Six-over-Six	526CM	726CM		826CM	926CM	282 lbs. (128.1 kgs)	84.25" (214.0 cm)	



MOTORIZED VIEWERS

The AMD motorized viewers blend the rigid standards of manufacturing with creative ingenuity to meet the individual needs of radiologists and medical institutions. Each model is designed to provide a cluster of features that best fit your practice's budget. AMD has been proud to represent the Planilux line of motorized viewers for over 25 years.



800.423.3535
www.digitalams.com



ALL VIEWERS FEATURE:

- Manufacturing to the highest quality standards
- Lighting and viewing characteristics that exceed ACR and MQSA guidelines
- Exceptionally quiet operation
- Variable light controls
- Ease of maintenance
- Flicker-free, high frequency lighting
- Both foot and hand controls
- Patient indexing ledgers
- Convenient AC power outlets on each side for use for auxiliary

MAMMOLUX™

AMD offers two precision-manufactured viewers specifically tailored for mammography. Both provide the same basic features and both exceed ACR and MSQA guidelines with full film masking. The Model 1360 accommodates up to 4 studies (18 x 24 cm) and the Model 680 up to 2 studies based on the same sized film.

ALL MAMMOLUX MODES PROVIDE:

- 15 programmable 4-way masking presets
- Variable luminance approximately 2,000-8,000 cd/m²
- Accommodates 18 x 24 cm, 24 x 30 cm and 14" x 17" films
- Joystick control for quick film masking
- Half-frame advance
- Storage of masking on frame-specific basis
- 10 x 10 cm bright spot opening which can be moved to any position on the viewing surface.
- Random frame selection
- Optional lock-out feature to help you meet HIPAA privacy requirements
- Easy loading, see-through film grips



Mammolux 680
15 programmable presets



Mammolux 1360
Accommodates up to four studies (18 x 24 cm)
15 programmable presets



Rotolux Model MVR-MJ-4

We have factory trained technicians and a large inventory of spare parts to support your equipment.

Magnifying glasses and high intensity BriteSpot Illuminators, see page 10.



ROTOLUX™

This high-capacity viewer provides silent operation, an abundance of features for accurate diagnosis, and a design that optimizes the radiologist's comfort during extended viewing periods.

Select from four different models, each with film capacities tailored to the individual requirements of each institution.



ALL ROTOLUX MODES PROVIDE:

- Exceptionally quiet operation
- Automatic dropped film retrieval
- Easy loading, see-through film grips
- Individual light panels with controls
- Unobstructed viewing field
- Up to 14" x 17" viewing areas

Rotolux Model MVR-P



ROTOLUX MODEL MVR-8

- All features above plus...
- Eight light panels with pressure sensitive light switches
- Two variable light controls, one for each viewing tier
- Master On/Off switch

ROTOLUX MODEL MVR-MJ-4

- All features of MVR-8 plus...
- Four motorized shutters on lower tier
- Upper tier with four individual 14" x 17" viewing areas
- Bottom tier with four individually controlled areas and panoramic lighting. Electronic shutter control adjusts to any size film

ROTOLUX MODEL MVR-P

- All features of MVR-8 & MVR-MJ-4 plus...
- 9 User-programmable presets
- Random frame selection
- Automatic frame-specific masking joystick control shuttering with nine presets



Rotolux Model MVR-8

Brand	Model	Capacity* (18x24/24x30cm)	Width	Height	Depth	ASW	Luminance (cd/m ²)	Power Consumption
<i>specifically designed for Mammography viewing with two-tiered viewing area with four motorized shutters over the full viewing area.</i>								
Mammolux	MVM-680-P	680	52" (132 cm)	64" (163 cm)	30" (76 cm)	898 lbs (407 kg)	7,700	6.0 amps
Mammolux	MVM-1360-P	1360**	72" (183 cm)	64" (163 cm)	30" (76 cm)	1,098 lbs (498 kg)	7,700	6.0 amps

* Mammolux units also accommodate 14"x17" films. MVM-680-P can display 170 films, and MVM-1360-P can display 340 films.

** 1020 - 24 x 30 cm films.

Brand	Model	Capacity*** (14" x 17")	Width	Height	Depth	ASW	Luminance (cd/m ²)	Power Consumption
<i>specifically designed for general viewing with two-tiered viewing area with a total of eight individually controlled 14"x17" viewing areas.</i>								
Rotolux	MVR-120-8	120	72" (183 cm)	78" (198 cm)	28" (71 cm)	825 lbs (374 kg)	5,500	7.0 amps
Rotolux	MVR-220-8	220	72" (183 cm)	78" (198 cm)	28" (71 cm)	935 lbs (424 kg)	5,500	7.0 amps
Rotolux	MVR-320-8	320	72" (183 cm)	78" (198 cm)	28" (71 cm)	968 lbs (439 kg)	5,500	7.0 amps
Rotolux	MVR-400-8	400	72" (183 cm)	78" (198 cm)	28" (71 cm)	1,001 lbs (454 kg)	5,500	7.0 amps

designed for general viewing with 2-tiered viewing, bottom with 4 motorized shutters, top with 4 individual 14" x 17" viewing areas.

Rotolux	MVR-120-MJ-4	120	72" (183 cm)	78" (198 cm)	28" (71 cm)	902 lbs (409 kg)	5,500	7.0 amps
Rotolux	MVR-220-MJ-4	220	72" (183 cm)	78" (198 cm)	28" (71 cm)	1,012 lbs (459 kg)	5,500	7.0 amps
Rotolux	MVR-320-MJ-4	320	72" (183 cm)	78" (198 cm)	28" (71 cm)	1,045 lbs (474 kg)	5,500	7.0 amps
Rotolux	MVR-400-MJ-4	400	72" (183 cm)	78" (198 cm)	28" (71 cm)	1,078 lbs (489 kg)	5,500	7.0 amps

designed for general viewing with 2-tiered viewing, bottom with 4 motorized shutters, top with 4 individual 14" x 17" viewing areas.

Rotolux	MVR-120-P	120	72" (183 cm)	78" (198 cm)	28" (71 cm)	902 lbs (409 kg)	5,500	7.0 amps
Rotolux	MVR-220-P	220	72" (183 cm)	78" (198 cm)	28" (71 cm)	1,012 lbs (459 kg)	5,500	7.0 amps
Rotolux	MVR-320-P	320	72" (183 cm)	78" (198 cm)	28" (71 cm)	1,045 lbs (474 kg)	5,500	7.0 amps
Rotolux	MVR-400-P	400	72" (183 cm)	78" (198 cm)	28" (71 cm)	1,078 lbs (489 kg)	5,500	7.0 amps

*** Each tier will hold sixteen 18 24 cm films in an 8-over-8 format or one row of six 24 x 36 cm films.



MORE PRODUCTS & ACCESSORIES

AMD offers one of the most extensive lines of personal radiation protective items.

Our garments are known for their excellent flexibility as a result of our multiply construction technique. We offer a wide variety of gloves and glasses, as well as a choice of colors that will meet most everyone's taste.

In addition, this section of the catalog features racks, stands, safelights, signs, x-ray film, film storage products, I.D. printers and more.



800.423.3535
www.digitalams.com



AMD offers you a complete assortment of high quality protective aprons. In selecting a protective garment, you can choose your size from one of our twelve models, many of which are in stock and ready for immediate shipment.

Also available are optional colors, fabrics, larger pockets, monogramming and enhanced protection. Ask for details.

NEW - Lite Lead and Non Lead options available. Lite Lead (add "-TL" for any model number) offers 0.5mm lead equivalency of regular lead at 100 kVp. Non Lead (add "-NL" to any model number) offer 0.5mm lead equivalency of regular lead at 90 kVp.

APRONS

Pictured below are five our most popular front protection aprons. All AMD aprons are created with multi-layer lead vinyl protection and stain-resistant nylon coverings. All aprons feature 0.5 mm front protection.



Buckle

Buckle Aprons

Our quick-release belt buckle system is easy to use and helps transfer the weight of the apron from the shoulders to the waist. The nylon exterior is easy to clean, yet flexible enough for hassle-free movement. 0.5 mm pb equivalent ASW = 10 lbs. (4.5 kgs.)



Easywrap

Easywrap Aprons

For those who prefer hook and loop fasteners, AMD offers the Easywrap model. The securing flap accommodates a large range of weights. Our full-cut backs provide extra support and comfort. 0.5 mm pb equivalent ASW = 10 lbs. (4.5 kgs.)



Economy

Economy Aprons

The quality and durability of all AMD aprons is now available in this economy model. Heavy duty vinyl covering, sturdy tie straps, and nylon edging make this durable apron a great value. 0.5 mm pb equivalent ASW = 10 lbs. (4.5 kgs.)

For ordering information, see page 26.



NEW - Flex Back Aprons

This apron features elastic back panels for added comfort and support with hook and loop fastening flaps that wrap around waist for an adjustable fit. Shoulder pads are included. 0.5 mm pb equivalent ASW = 10 lbs. (4.5 kgs.)



NEW -Back Relief Aprons

Our Back Relief Apron transfers the weight from the shoulders to the hips with the aid of a 6" wide elastic belt. Adjustable back shoulder strap keeps the apron snug. Shoulder pads are included. 0.5 mm pb equivalent ASW = 10 lbs. (4.5 kgs.)

ASW= Approximate Shipping Weight



SPECIAL PROCEDURE APRONS



Surgery Dropoff

Liberal use of hook and loop closures holds this apron securely while in use. A quick pull at the waist allows the apron to drop. No more hard-to-reach releases or long straps to get tangled.

0.5 mm pb equivalent
ASW = 11 lbs. (5.0 kgs.)

Half Aprons

This half apron is used to protect the patient's or technician's sensitive gonad region. You can also remove the leaded shield from its belt and use it as a film blocker.

0.5 mm pb equivalent
ASW = 8 lbs. (3.6 kgs.)



Vest/Skirt Combination

The AMD two-piece vest and skirt offers full wraparound protection with improved mobility and weight distribution. The 0.5mm pb equivalent vest overlaps in front for a 1.0mm pb equivalency. The 0.3mm pb skirt overlaps in front for a 0.6mm pb equivalency.

ASW = 17.7 lbs. (7.7 kgs.)



Special Procedure Wraparound

These AMD aprons feature hook and hoop closures for positive fastening and easy on/off convenience. Full 0.5mm pb equivalent protection is provided. Overlapping front panels provide a full 1.0 m pb equivalency in critical areas.

ASW = 17.7 lbs. (7.7 kgs.)

ASW= Approximate Shipping Weight

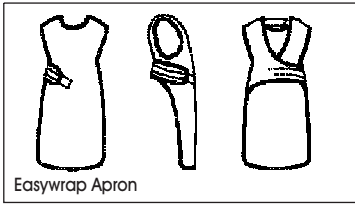

Easywrap Apron

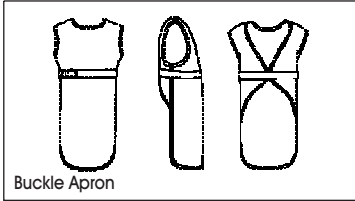

Buckle Apron

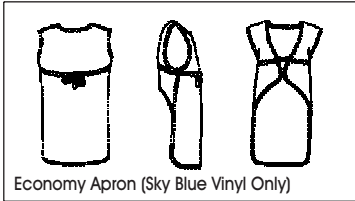

Economy Apron (Sky Blue Vinyl Only)

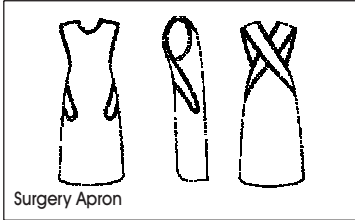

Surgery Apron

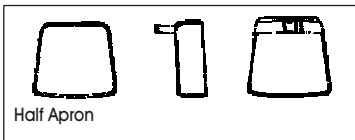

Half Apron

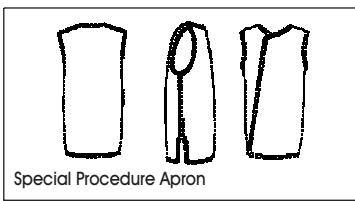

Special Procedure Apron

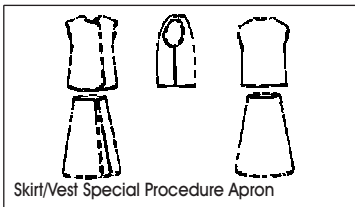

Skirt/Vest Special Procedure Apron



#12 Royal Blue



#20 Mauve



#13 Navy



#21 Blue



#14 Red



#22 Lime Green



#15 Maroon



#23 Hot Pink



#16 Forest Green



#24 Teal



#17 Silver



#25 Tan



#18 Purple



#26 Fuchsia



#19 Pink



#27 Charcoal

Ordering Information¹

Radiation Protective Products

Apron Description	Model No.		
	Petite	Average	Tall
Width/Height	20"x32"	24"x34"	24"x36"
Front Protection Aprons			
Flex Back	22105	22115	22125
Back Relief	22205	22215	22225
Buckle	20105	20115	20125
Easywrap	20605	20615	20625
Economy	20205	20215	20225
Surgery Dropoff	20505	20515	20525
Half Apron	20705	20715	
Width/Length			
SpecialProcedure	20305	20315	20325
Width/Length			
Vest/Skirt	20405	20415	20425
Weight of user	to 100 lbs	100-140 lbs	140 lbs +
5-Finger Gloves (15" length)			
Dark Blue Vinyl	20801-DB		
Burgundy Vinyl	20801BU		
Black Leather	20801-BK		
Fawn Leather	20801-FA		
Super-Flex² (15" length)	20806	20807	20808
20810 - Cotton Inserts-one size			
Lead Mittens (15" length)			
Blue Vinyl	20803-BL		
Black Leather	20803-BK		
Blue Vinyl with Palm Slit	20804-BL		
Black Leather with Palm Slit	20804-BK		
Open Palm Mitts	20805		
Vet Mitts	20802		

1-All aprons, except Economy aprons, are made from nylon fabric and finished trim. Economy aprons are made with vinyl material. Veterinary aprons may be ordered with special heavy duty "Herculite" material in sky blue and royal blue only.

2 - Each pair comes with cotton inserts. Additional inserts may be ordered by the pair (model 20810).

NEW - Lite Lead and Non Lead options available.

Lite Lead (add "-TL" for any model number) offers 0.5mm lead equivalency of regular lead at 100 kVp.

Non Lead (add "-NL" to any model number) offer 0.5mm lead equivalency of regular lead at 90 kVp.



DENTAL APRONS

AMD offers a variety of dental aprons for both the patient and the technologist. A standard 0.3mm pb equivalency protection is provided. Other protective values can be specially ordered.



A. Cling-Cover™ Patient Apron

The Cling-Cover provides the most complete patient protection. The neck, throat, chest, shoulders and gonadal areas are all covered. Our single hook and loop closure provides easy and fast adjustments.

ASW = 7 lbs. (3.2 kgs.)



B. Sure-Hold™ Patient Apron

The unique foam backing on this apron keeps the apron in place by "gripping" the patient's clothing. No ties or fasteners are used.

ASW = 6 lbs. (2.7 kgs.)



C. Dental Technologist's Apron

This 0.3mm apron provides excellent protection, while remaining lightweight and comfortable to wear for extended periods of time. Easy-to-use ties provide for fast adjustment and a secure fit.

ASW = 8 lbs. (3.6 kgs.)

D. Panoramic Poncho Patient Apron

For panoramic dental exams this apron provides excellent protection. Both front and back coverage is provided. A simple hook and loop shoulder closure is used.

ASW = 7 lbs. (3.2 kgs.)

Ordering Information - Radiation Protective Products			
Apron Description	Model No.		
	Petite	Average	Tall
Dental Technologist	21405	21415	21425
Width/Height	20"x32"	24"x34"	24"x38"
	Pediatric	Adult	
Panoramic Poncho	21305	21325	
Width/Height	23"x12"	23"x24" front & 12" back	
Cling-cover	21205	21215	
Width/Height	19"x22"	23"x38"	
Sure-Hold	21105	21115	
Width/Height	19"x21"	23"x36"	

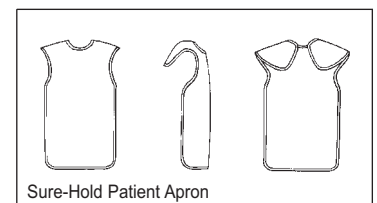
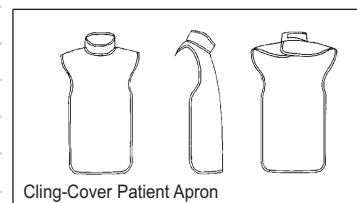
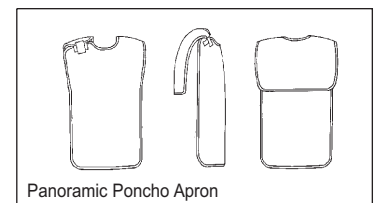
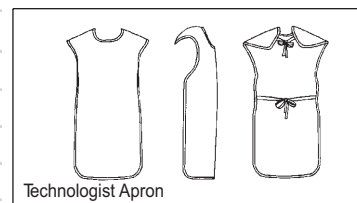

Choose from four models that incorporate all the features of our standard product line.

Vest/Skirt Apron



STORAGE RACK

To ensure years of safe use, AMD offers everything from single garment hanging devices to high capacity models..

Glove and Apron Rack

Protect your gloves and aprons from unnecessary damage. Our popular combination rack allows you to store gloves, aprons and glasses

20835 - 28" w x 16" h x 6" d (71.1 x 40.6 x 15.2 cm)
ASW = 10 lbs. (4.5 kgs.)

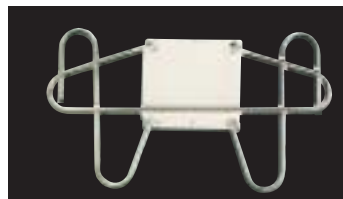

Model 20835

Five-Arm Apron Rack

For large clinics, this five-arm rack solves your large storage needs within a small space. It can be ordered right or left folding.

20831 - Right folding

20833 - Left folding

28" w x 13.5" h x 4" d (71.1 x 34.3 x 10.2 cm). When extended, a 27" clearance is required.

ASW = 14 lbs. (6.4 kgs.)



Model 20835
With garments



Model 20831

Apron Hanger

This attractive, chrome-plated 1/4" steel hanger will hold up to 50 pounds of aprons.

Model No. **10830**

ASW = 1.0 lbs. (0.4 kg)



Model 10830

THYROID COLLARS



Pliable and comfortable, our 0.5mm lead protective collar accommodates neck sizes up to 20" (51 cm). Convenient hood and loop closure.

Model 20996 - Attached to apron - 1 lbs (0.4 kg)

Model Unattached - Unattached - 1 lbs (0.4 kg)

LEAD VINYL SHEETING



10% lighter in weight compared to equivalent lead rubber. We assure uniform density, acid and alkali resistance, and sanitary, non-absorbent surfaces on both sides. Available in all common sizes, as well as 24" wide sheeting.

Ordering Information

Description	Model No.	ASW
Sheeting		
0.25 mm Lead Equivalency	20845	0.75 lbs/sq.ft. (0.4 kg)
0.50 mm Lead Equivalency	20850	1.5 lbs/sq.ft. (0.7 kg)
1.00 mm Lead Equivalency	20855	3.0 lbs/sq.ft. (1.4 kg)
Lead Blockers (1.0 mm pb equivalency)		
4" x 10"	20601	
5" x 8"	20603	
5" x 12"	20604	
5.5" x 14"	20607	
6" x 10"	20609	
7" x 10"	20611	
7" x 17"	20613	
8.5" x 14"	20616	
8.5" x 17"	20617	

Other dimensions and lead equivalencies can be special ordered.

GONAD/OVARIAN SHIELDS

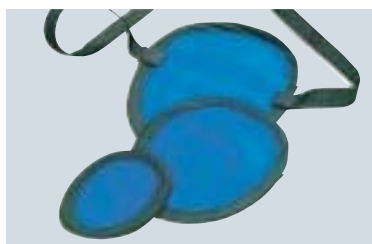

Set of three shield with tie straps

Model 20811 - S, M, L-2 lbs (0.9 kg)



NEW ADDITIONS - GLOVES AND MITTENS

A. Standard Five-Finger Gloves - These 15" gloves combine the protection of a one-piece molded process with superior flexibility. Gloves are lined with a soft but durable expanded foam and covered in a durable vinyl. Available in two colors, pairs or singles. Standard protection is 0.5mm pb eq.

B. Leather Covered Five-Finger Gloves - These 15" one piece dip-molded lead gloves feature durable goatskin leather covers and foam liner. Available in two colors, pairs or singles. Standard protection is 0.5mm pb eq.

C. Lead Mittens - These Lead Mittens are a 15" one piece dip molded mitten featuring soft supple black goat skin leather cover with a foam liner. They provide full hand and palm protection. Come in slitted and non slitted versions. Standard protection is 0.5mm pb eq.

D. Super-Flex Gloves - Particularly ideal for the emergency room area, these molded lead gloves take advantage of new technology to provide increased dexterity. Our special surface sealant eliminates the need for an outside cover, minimizing the gloves' thickness and making them easy to clean and sterilize (may be sterilized with ethylene oxide). Standard protection is 0.5mm pb eq.

E. Open Palm Mitts - Veterinary - Open Palm Vet Mitt shields the back of the hand and features hook and loop strap closure across the palm for quick removal. The open Palm Vet Mitt is covered in dark blue webblon. Standard protection is 0.5mm pb eq.

F. Vet Mitts - Designed for vets as a cost effective solution, the Vet Mitt features palm slits allowing fingers to exit for freedom of movement during radiography. Contour cut to fit the arm and covered in royal blue nylon. Standard protection is 0.5mm pb eq.



A. Standard Five-Finger Gloves



B. Leather Covered Five-Finger Gloves



C. Lead Mittens



D. Super-Flex Gloves



E. Open Palm Mitts



F. Vet Mitts

Ordering Information

Description	Model No.	ASW
Standard Five-Finger Gloves (15" length)		
Dark Blue Vinyl	20801-DB	5 lbs (2.2 kgs)
Burgundy Vinyl	20801-BU	5 lbs (2.2 kgs)
Leather Covered Five Finger Gloves (15" length)		
Black	20801-BK	5 lbs (2.2 kgs)
Fawn	20801-FA	5 lbs (2.2 kgs)
Super-Flex Gloves (15" length)		
Small	20806	3 lbs (1.4 kgs)
Medium	20807	3 lbs (1.4 kgs)
Large	20808	3 lbs (1.4 kgs)
Additional Cotton Inserts	20810	0.2 lbs (0.1 kg)
Mittens		
Black Leather	20803-BK	5 lbs (2.2 kgs)
Blue Vinyl	20803-BL	5 lbs (2.2 kgs)
With Palm Slit - Blue Vinyl	20804-BL	5 lbs (2.2 kgs)
With Palm Slit - Black Leather	20804-BK	5 lbs (2.2 kgs)
Open Palm Vet Mitt	20805	2 lbs (0.9kgs)
Vet Mitt	20802	3 lbs (1.4 kgs)



NEW - PROTECTIVE EYEWEAR



Ultra Flex Glasses - This eyewear features our advanced nylon composite frames with uni-fit ear and nose pieces for comfortable wear. Fits well for those with larger facial features. Available with optional side shields.

Front protection is 0.7mm pb eq. Side shields offer 0.5mm pb eq.

- 20820-BK** - Black Frame
- 20820-RD** - Red Frame
- 20820-SL** - Silver Frame
- 20820-BK-S** - Black Frame with side shields
- 20820-RD-S** - Red Frame with side shields
- 20820-SL-S** - Silver Frame with side shields



Astro Flex Glasses - This eyewear features full field panoramic view with adjustable temple length and frame angle for a uniform fit. Available with optional side shields.

Front protection is 0.7mm pb eq. Side shields offer 0.5mm pb eq.

- 20821** - Astro Flex
- 20821-S** - Astro Flex with side shields



Wrap Around Glasses - Wrap Around eyewear features comfortable molded wrap styling in durable tortoise nylon frame with a uni-fit bridge and leaded side shields. These glasses provide excellent peripheral visibility.

Front and side lenses offer 0.75 pb eq.

- 20823** - Wrap Around Glasse



Steel Frame Glasses - This eyewear is constructed of optical steel base metal and gold electro-plate and adjustable non-slip silicon nose pads for maximum comfort. Optional fitted side shields increase scatter radiation protection.

Front protection is 0.7mm pb eq. Side shields offer 0.5mm pb eq.

- 20822** - Steel Frame
- 20822-S** - Steel Frame with side shields

NEW - MOBILE BARRIERS

Here are three models of these increasingly hard-to-find products. The models featuring clear acrylic come in a generous 30" width. The glass window models come in a larger variety of sizes.

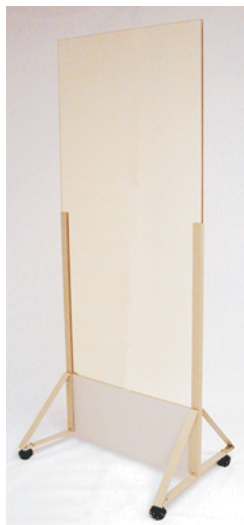

Regular Clear Pb Barrier - Clear Pb Acrylic Mobile X-Ray Barriers feature optically clear and shatter resistant acrylic. The regular size features a window panel of 25"h x 30"w with 0.5mm pb eq. The opaque panel size is 48"h x 30"w with .08mm pb eq.

- 20950** - 25"h x 30"w Clear - 75"h x 30"w overall - 114 lbs.

Jumbo Clear Pb Barrier - Clear Pb Acrylic Mobile X-Ray Barriers feature optically clear and shatter resistant acrylic. The regular size features a window panel of 60"h x 30"w with 0.5mm pb eq. The opaque panel size is 12"h x 30"w with .08mm pb eq.

- 20951** - 60"h x 30"w Clear - 75"h x 30"w overall - 119 lbs.

Standard Mobile Screens - These screens feature 1.5mm (1/16") virgin lead lining, framed with heavy metal channeling, heavy-duty stainless steel legs and locking casters to ensure stability. The lead glass window has a minimum 2.0mm lead equivalent protection and is positioned with a center of view 5'3" up from the finished floor. Screens and windows available in many sizes.

- 20952** - 24"h x 72"w
- 20953** - 24"h x 84"w
- 20954** - 30"h x 72"w
- 20955** - 30"h x 84"w
- 20956** - 36"h x 72"w
- 20957** - 36"h x 84"w

To specify window size add one of the following to any model number.

- 08" for 8" x 10" window*
- 10" for 10" x 12" window*
- 12" for 12" x 12" window*



TRADITIONAL HIGH OUTPUT FLUORESCENT SAFELIGHTS

We call these our ClearVue Safelights. They are the low-cost, high-output answer to your darkroom illumination needs. Choose from six different models that offer many outstanding features. Safe for green and blue base films.

All units come complete with a 6' line cord and pull chain style on/off switch. The unique triangular design of the ClearVue safelight allows you to mount them to give either direct or indirect light. Units are UL listed.

SPOT SAFELIGHTS

AMS offers two styles of Spot Safelight: one with an adjustable base, and one designed to mount in a standard "screw-in" electrical base. Both models use an industry standard 5.5" diameter filter, but higher-powered 15-watt lamp. Safe for green and blue base films. All modes are UL listed.

Model 30701 - Edison Base

Model 30703 - Adjustable base with pull chain on/off switch; 6' power cord.



Model 30715 - 15-Watt Fluorescent 18" Tube

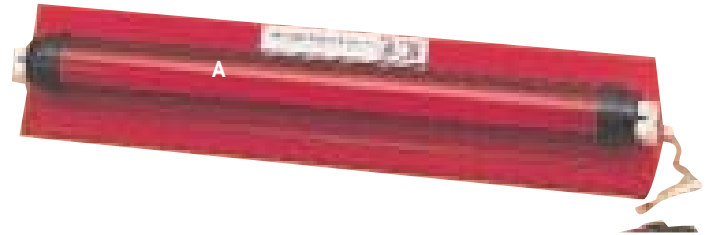

DELUXE FLOOD-STYLE SAFELIGHT

The Deluxe AMD Safelight is the ultimate in durability and flexibility. It provides the brightest illumination while remaining "safe" under darkroom conditions. An adjustable housing adapts this safelight to any mounting position. Most important, our unique double filter system assures safety for both monochromatic and orthochromatic film types. Comes with a 6' power cord with an in-line on/off switch.



RECESSED CEILING SAFELIGHTS

Our ceiling-mounted safelights are designed to be wired directly into the darkroom's general electrical system. Both safelight and white light models are available. Safe for green and blue base films.

Model 30751 - Single safelight

Model 30753 - Double fixture: one each safelight and white light

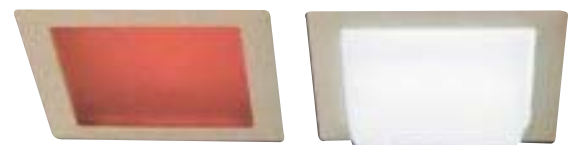

Model 30753

SPOT SAFELIGHTS	MODEL	WEIGHT	NOTES	APPROX. DIMENSIONS
Edison Base	30701	3 lbs (1.4 kgs)	15-watt/5.5" filter	9.5"h x 5.56"w x 5.56"d (24.1 x 14.1 x 14.1 cm)
Adjustable Base	30703	3 lbs (1.4 kgs)	15-watt/5.5" filter	9.5"h x 5.56"w x 5.56"d (24.1 x 14.1 x 14.1 cm)
STANDARD FLUORESCENT	30715	8 lbs (3.6 kgs)	15-watt/18" tube filter	3"h x 4.625"w x 18" d (7.5 x 11.6 x 45 cm)
DELUXE FLOOD	30742	5 lbs (2.3 lbs)	9-watt/7"x10" filter	7.5"h x 9.5"w x 7"d (19.1x 31.8 x 17.8 cm)
RECESSED CEILING				
One-Sided	30751	5 lbs (2.3 kgs)	15-watt safelight	14.75"h x 9.5"w x 4.75"d (34.5 x 24.1 x 12.1 cm)
Double-Sided	30753	10 lbs (4.5 kgs)	15-watt safelight 75-watt white light	32"h x 9.5"w x 4.75"d (81.3 x 24.1 x 12.1 cm)

Exclusive Safety Testing - These fixtures have been tested to insure that they are safe for a representative range of x-ray films. Tests were conducted using both direct and indirect lighting conditions. For the more critical condition, direct lighting, these products have been tested at 4.5 feet from the working surface.



I.D. PRINTERS

Our QuickPrint™ features automatic exposure control, adjustable lighting for blue, green and mammography films and visual exposure indication. Our unique LCD light panel assures a clear, even transfer of information from the patient ID cards.

- Battery and AC models
- Standard cassette or window cassette set-ups

Description	MODEL	WEIGHT	APPROX. DIMENSIONS
Battery Unit	30630	2 lbs (0.9 kgs)	7.75"h x 7.75"w x 3"d (19.7 x 19.7 x 7.6 cm)
A/C Unit	30640	2 lbs (0.9 kgs)	7.75"h x 7.75"w x 3"d (19.7 x 19.7 x 7.6 cm)

INFORMATION SIGNS

We designed the information signs to provide the maximum possible visibility and readability. Standard models include:

- X-RAY IN USE (Model 90oX)
- DARKROOM IN USE (Model 900DR)
- CT IN USE (Model 900CT)
- MRI IN USE (Model 900MR)

The signs may be flush-mounted to walls, end-mounted to project into a hallway, or ceiling-hung. All fixtures are easily installed. AMD information signs are finished in an attractive off-white finish and are UL listed. The standard model provides a 120 volt input.

Size: 7.875"h x 11.5"w x 2.375"d (20.0 x 29.2 x 6.0 cm)
 ASW = 4 lbs (2.5 kgs)
 Light Source: Two 25-watt incandescent lamps (not included)



FILM SAFES

Never worry again about accidental exposure of stored film. The Film Safe can only be opened under safelight conditions. Accidental exposure is virtually impossible. Here's how it works. To open the Film Safe, press the lock release. The solid state components in the unit will measure the amount of light in your darkroom and if safe, the lid is released for removal or insertion of film. The lid is designed to "fall" closed when released.

Features & Benefits

Light-sensitive door lock - Prevents accidental opening and film exposure.

Compact size - Large inside storage.

Lightweight - Under Counter (30774), Table Top (30772) or Shelf Mount (30770)

Various Sizes - Small unit holds up to 10" x 12" film sizes.; Large unit holds sizes up to 14" x 17"



Model 30770



Model 30774

SAFE-T-LOCK™

Our Safe-T-Lock, with its patented film bin locking system, uses a light sensitive eye that measures safelight conditions. It allows your technicians to open the film bin only when safelight conditions exist. Used correctly, the Safe-T-Lock makes it impossible to expose your film supply to white light. When the film bin is open in safe-light, a soft beep is emitted to remind the technician to close the film bin after use. For the price of a box of film you can't afford another day without this indispensable safeguard against accidental film exposure! Six screws adapt your existing film bin with the Safe-T-Lock.



Model 30778

Material: ABS Light Gray
 Power source: Three 9-volt batteries (included)



NEW - CD/DVD MAILERS & FILERS

With the transition to digital imaging, more physicians are eliminating film copies and moving to giving patients and referring physicians copies on CD. Here's a convenient and cost effective mailing solution.

XRC0505-M - CD/DVD Mailers - Made of 20 pt. coated white board, these mailers feature a self-adhesive closure and tear-tape tab opening. The interior has a pink anti-static and anti-scratch liner. Carton of 250. 17 lbs (7.7 kgs)



Jewel Case Mailers



CD/DVD Mailers



CD/DVD Filers

XRC0505-J - Our Jewel Case Mailers feature self-adhesive closure and tear-tape openings. They are made of white E-flute cardboard and are easy to assemble. Carton of 250. 20 lbs (9.1 kgs)

XRC0505-F - Our CD/DVD Filers are 5" x 5" and made of 60 lb. white offset paper stock. The window is made of clear polyester. Carton of 1,000. 14 lbs (6.4 kgs)

FILM MAILERS & FILERS



Negative Preservers - Available in three sizes to accommodate all films. Each printed label includes lines to mark file number, name, date, doctor and remarks. Preservers are made of 32 lb. gold kraft stock. These open on the short side edge with a thumbcut for easy access to films. Red and green colors are available in the large size format upon special request.

XRF0810 - For 8" x 10" films - 500 per case - 25 lbs (11.4 kgs)

XRF1012 - For 10" x 12" films - 500 per case - 25 lbs (11.4 kgs)

XRF1417 - For 14" x 17" films - 250 per case - 22 lbs (10.0 kgs)



Mailers - Available in two sizes. Made of 32 lb. brown kraft stock, each mailer opens on the short side edge and has a string and button closure for easy reuse. A cardboard insert is included to provide rigidity in mailing. Printed with a bold black stock copy.

XRM0810 - For 8" x 10" films - 500 per case - 25 lbs (11.4 kgs)

XRM1012 - For 10" x 12" films - 500 per case - 25 lbs (11.4 kgs)

XRM1417 - For 14" x 17" films - 250 per case - 22 lbs (10.0 kgs)



NEW - Deluxe Mailers - Available in two sizes. Made of 11 pt manila stock, each mailer opens on the short side edge and has a string and button closure for easy reuse. Printed with a green diamond border and a red "X-Ray Film, please do not bend" warning.

XRD1113 - 11" X 13" - 100 per case - 14 lbs (6.4 kgs)

XRD1518 - 15" x 18" films - 500 per case - 20 lbs (9.1 kgs)

CD/DVD & FILE CARRIERS



NEW - CD/DVD and File Carriers - Stay organized and protect patient files and CD's. Available in five colors each has two full sized pockets. A CD/DVD pouch is located on the front. Available in willow gray, forest green, burgundy, ivory and walnut brown.

XRC1417-WG - Willow Gray-14"X17"-20 per case-14 lbs (6.4 kgs)

XRC1417-FG - Forest Green-14"X17"-20 per case-14 lbs (6.4 kgs)

XRC1417-BU - Burgundy-14"X17"-20 per case-14 lbs (6.4 kgs)

XRC1417-IV - Ivory-14"X17"-20 per case-14 lbs (6.4 kgs)

XRC141-WB - Walnut Brown-14"X17"-20 per case-14 lbs (6.4 kgs)



FILM STORAGE BOXES

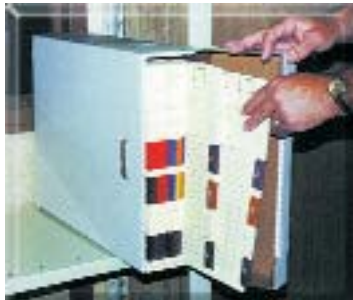

NEW - Film Storage Boxes - These boxes allow for the efficient storage of x-ray film files. They are sold in case lots of 15 boxes per case. Each has strong and durable reinforced handles for easier carrying. They can be stacked without crushing and accommodate jackets for films up to 14" x 17". Lid is on the short side.

XRS1417 - Case of 15 - 30 lbs (13.6 kgs)



Side Load



Top Load

WALL FILM & RECORDS HOLDER

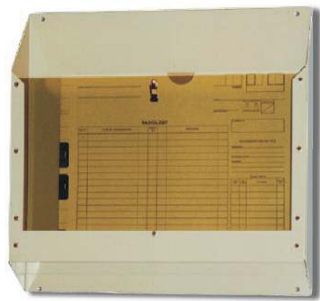

XRH1422

NEW - Wall Film & Records Holder - These units are made of steel and have polycarbonate viewing panels. Designed to hold our film caddies, film filers and even cassettes. Each bin has a convenient message clip.

XRH1422 - 22"w x 5"d x 14"h - 25 lbs (11.4 kgs)

NEW - Chart & X-Ray Film Holder - These units feature a smoked clear polycarbonate front with a steel backboard and base. Sides are open for easy in and out. Each unit has a convenient message clip. A rubber mat along the base keeps folders from sliding. Designed to hold charts, caddies, films, etc.

XRH1412 - 14"w x 3"d x 12"h - 8 lbs (3.6 kgs)



XRH1412

IMPROVED - STACKABLE CABINETS



No tools, no pins and no hardware is required to put these cabinets together. Each component is individually boxed for easy unloading. Easy handling and set-up for facilities with minimal staff. UPS shippable.

50301 - X-ray Shelves hold folders for 14" x 17" film. Shelves are 32"w x 19"d x 16.5"h. Vertical clearance is 15.125" - 38 lbs (17.3 kgs)

50310 - X-Ray Base - 2" base - 7 lbs (3.2 kgs)

50320 - X-Ray Cover - 5 lbs (2.3 kgs)

50340 - X-Ray Locking Doors - 5 lbs (2.3 kgs)

50101 - Records Shelves hold medical records and small films. Shelves are 32"w x 12"d x 12.625"h. Vertical clearance is 11.25" - 23 lbs (10.5 kgs)

50110 - Records Base - 2" base - 6 lbs (2.7 kgs)

50120 - Records Cover - 4 lbs (1.8 kgs)

50130 - X-Ray to Records Filer - 2 lbs (0.9 kgs)

50140 - Records Locking Doors - 4 lbs (1.8 kgs)



New locking doors



All records



All X-Ray



X-RAY FILING CABINETS



50410



50414

Built Tough X-Ray Filing Cabinets - These units are shipped fully assembled and are suitable for outer offices as well as file rooms. Built with all steel nut and bolt construction for maximum strength. Solid backs and side panels add to security. Almond is the standard color but custom colors are available.

Other features include:

- Narrow compartments: dividers are 6" apart
- 15 3/8" vertical shelf clearance.
- 12-gauge corner posts for maximum vertical strength
- Full height dividers add vertical strength and stability
- Full depth dividers prevent snagging and ripping of film jackets.

50410 - 36"w x 18"d x 84"h - 238 lbs (108.2 kg)

50412 - **New with locking doors.**

36"w x 18"d x 84"h - 288 lbs (130.9 kg)

50414 - 48"w x 18"d x 84"h - 295 lbs (134.1 kg)



50422



50424

Built Tough Mammo & Records Cabinets

50420 - 36"w x 12"d x 81"h - 162 lbs (73.6 kg)

50422 - **New with locking doors.**

36"w x 12"d x 81"h - 198 lbs (90.0 kg)

50424 - 48"w x 12"d x 81"h - 202 lbs (91.8 kg)

Built Tough Digital Media Storage Cabinets - These units are ideal for storing bulk supplies and digital media. Secure your media with locking door. Units ship fully assembled and are suitable for outer offices as well as file rooms. Built with all steel nut and bolt construction for maximum strength. Solid backs and side panels add to security. Black is the standard color but custom colors are available.

Other features include:

- 11 3/4" vertical shelf clearance
- 12" deep x 36" wide shelves
- Open shelf design (no dividers)

50430 - 36"w x 13"d x 81"h - 157 lbs (71.4 kg)



50430



NEW - DIGITAL SUPPORT CARTS

Use these carts anywhere you need mobile computer. Ideal for CR readers, film digitizers and other PACS equipment. Comes in two general sizes (18" and 24" widths) and three shelf configurations.

Height of open shelves are 9", 10" and 9" respectively. Vertical divided spaces are 3", 3" and 12" respectively on 18" wide carts and 6", 6" and 12" respectively on 24" wide carts.

Wire access holes are provided in the back and on the laminated top for adding a monitor mount.

Optional Monitor Support --> Monitor post mounts into standard hole in the cart's laminated top. Height adjusts with a screw crank so that stability is maintained. Includes standard VESA mount.



DIGITAL SUPPORT CARTS				
Model No.	Base Width	Top Size	Shelf Layout	Compatible Suggestions
182022-A	18"	20"w x 22"d	Upper Shelf / Lower Slots	VIDAR Sierra Advantage, Radlink LaserPRO 16, LogicRAD, AllPro Scan12, Protect ProScan35
182022-B	18"	20"w x 22"d	Upper Slots / Lower Shelf	
182022-C	18"	20"w x 22"d	Three Shelves	
182525-A	18"	25"w x 25"d	Upper Shelf / Lower Slots	VIDAR Diagnostic Pro Advantage, Kodak/Carestream DryView 5800/580, Fuji DryPix2000, Konica/Minolta DryPro 832, Codonics Horizon
182525-B	18"	25"w x 25"d	Upper Slots / Lower Shelf	
182525-C	18"	25"w x 25"d	Three Shelves	
242525-A	24"	25"w x 25"d	Upper Shelf / Lower Slots	VIDAR Diagnostic Pro Advantage, Kodak/Carestream DryView 5800/580, Fuji DryPix2000, Konica/Minolta DryPro 832, Codonics Horizon
242525-B	24"	25"w x 25"d	Upper Slots / Lower Shelf	
242525-C	24"	25"w x 25"d	Three Shelves	
243030-A	24"	30"w x 30"d	Upper Shelf / Lower Slots	VIDAR Diagnoststic Pro Advantage, Kodak DryView 5800/580, Array 2905, AllPro ScanX 14 Agfa CR30/Quantum CR30, Kodak CR120/140/260/500, Sony Filmstation
243030-B	24"	30"w x 30"d	Upper Slots / Lower Shelf	
243030-C	24"	30"w x 30"d	Three Shelves	
243621-A	24"	36"w x 21"d	Upper Shelf / Lower Slots	VIDAR Diagnostic Pro Advantage, iCRCO 612SI/2000SL, Agfa DryStar 5300. AllPro ScanX 14, iCRCO 3600
243621-B	24"	36"w x 21"d	Upper Slots / Lower Shelf	
243621-C	24"	36"w x 21"d	Three Shelves	
Options				
182000			Door for 18" Wide Cart	
242000			Door for 24" Wide Cart	
182010			Monitor Support	



FILM MARKERS

Markers - Aluminum Casing - These are the most durable markers available. Red is the standard color for "R" markers and blue for "L". Other colors are available.

- 30815 - R & L marker set - 5/8" rectangle size.
- 30818 - R & L marker set - 1" rectangle size.
- 30803 - R & L marker set with position indicator - 5/8" rectangle size
- 30824 - Arrow

Now Lead-Free



30815

30818

30803

Now Lead-Free



30824

Markers - Injected Molded - These are made high impact, white polystyrene casing. Red is the standard color for "R" markers and blue for "L". Other colors are available.

- 30838 - R & L marker set - 5/8" rectangle size.
- 30839 - R & L marker set - 1" rectangle size.
- 30848 - R & L marker set with position indicator 5/8" rectangle size
- 30841 - Arrow

Now Lead-Free



30838

30839

30848

Now Lead-Free



30841

NEW - Markers - Wafer Thin - These markers are designed to be super thin for slim bucky clearance. Perfect for new CR and DR equipment. These markers are only 18/32" (2mm) thick and are made with copper filters for a broad range of KV.

- 30863 - R & L marker set - 3/8" rectangle size.
- 30865 - 1/2" Arrow



30863

30865

R & L Clip - This clip marker is constructed of high strength Kydex™. Markers are 3/4" tall and the complete clip is 1 7/8" wide.

- 30854 - R & L Clip marker



NEW - Mammography Marker Sets - These marker sets come with one of four holding system: Velcro, Suction Cup, Magnetic or none. See chart below for what is included in the Screening ACR vs. Basic ACR sets (3 lbs (1.4 kgs))

Screen ACR Mammo Set - Includes RCC, LCC, RMLO, LMLO, RML, LML, RLM and LLM

- 30910-S - Standard Set
- 30910-V - Velcro Set
- 30910-SC - Suction Cup Set
- 30910-M - Magnetic Set

Basic ACR Mammo Set - Includes CC, MLO, LMO, ML, LM, XCCL, CV, AT, TAN, ID, SIO, FD, RM, RL, RI, M, L, R

- 30920-S - Standard
- 30920-V - Velcro
- 30920-SC - Suction Cup
- 30920-M - Magnetic

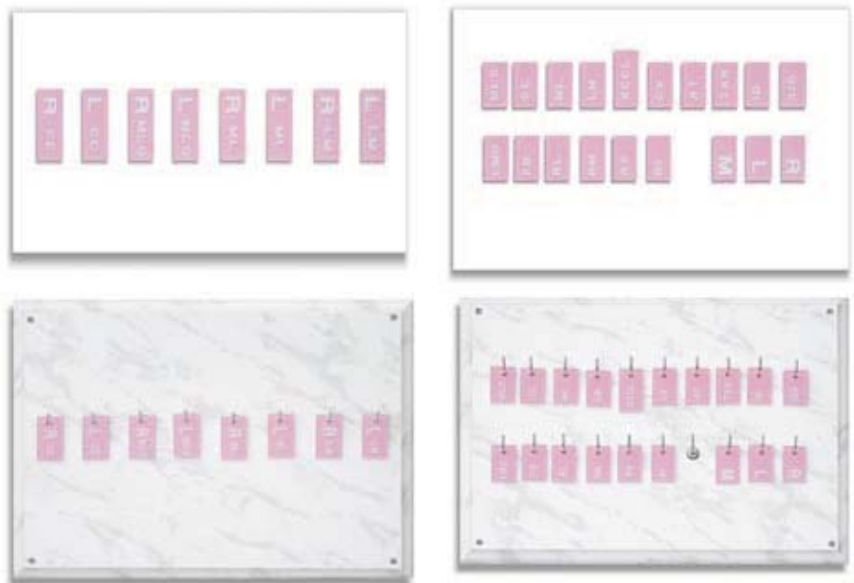

Magnetic sets include markers with magnetic backing that stick to a white metal wallboard which is attached with Velcro to the wall or equipment. This can be mounted horizontally or vertically.

ACR Standardized Abbreviations

BASE (1/4" letters)	MLO (Mediolateral Oblique) CC (Craniocaudal) ML (Mediolateral) LM (Lateromedial) XCCL (Exaggerated Craniocaudal) CV (Cleavage) AT (Axillary Tail) TAN (Tangential) ID (Implant Displace) SIO (superolateral to Inferomedial Oblique) LMO (Lateromedial Oblique) FB (From Below)	PREFIX (7/16" letters)	R (Right) L (Left) M (Magnification)
		SUFFIX (1/4" letters)	RL (Roll Lateral) RM (Roll Medial) RS (Roll Superior) RI (Roll Inferior)
		DEGREES (1/4" letters)	(no standard)
		INITIALS (1/4" letters)	(no standard)



SANDBAGS

All sandbags are filled with sand and are ready to use. They have a heat sealed inner sleeve to help prevent sand leakage. All seams are sewn and tear resistant. The deep green outer cover is heavy gauge, reinforced vinyl. Each sandbag has a reinforced webbing handle.



SANDBAGS

Model No.	Weight	Size
10270	1-lb	4" x 5"
10266	2-lb	4" x 9"
10286	3-lb	5" x 9"
10268	5-lb	5" x 12"
10288	5-lb	7" x 9"
10262	5-lb	9" x 9"
10282	7-lb	10" x 10"
10264	7-lb	6" x 14"
10284	10-lb	7" x 16"
10226	10-lb	11" x 11"
10228	15-lb	12" x 12"
10230	20-lb	12" x 14"

TABLE PADS

These pads can be used for x-ray tables or stretchers. They are made of heavy gauge vinyl with welded seams. Standard color is light blue. Four brass eyelets are used for hanging (two located at either end). Cleans with mild cleaner or germicide wipes. Pads over 1.25" (32mm) thick are not recommended for diagnostic x-ray use.

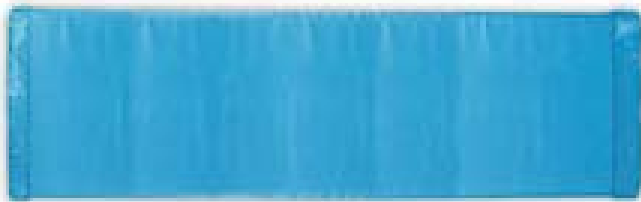

10164 - Standard - 23 1/4" w x 72" l x 1" t
10170 - Half - 23 1/4" w x 36" l x 1" t
10176 - Storage Rack



WALL PAD RACK - Two hooks on 12" centers with mounting holes on 16" centers. Made of steel with white finish. Shipping weight - 4 lbs (1.8 kgs)



PATIENT TRANSFER BOARDS

NEW - These boards facilitate the efficient transfer of patients. They are constructed from a semi-flexible, slick material that makes positioning under the patient easy. Durable, easy to clean and made of white high-density polyethylene. Ideal for general imaging, MRI and CT. They are radiolucent and have conveniently located 1.5" x 4.5" hand holds.

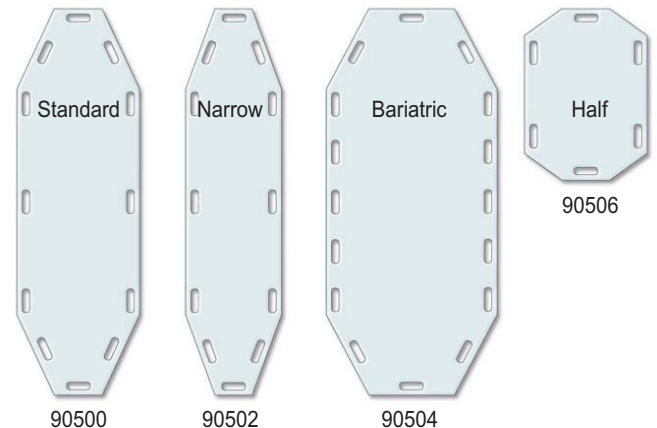

90500 - Standard - 23" w x 72" l x 3/16" t
90502 - Narrow - 18" w x 72" l x 3/16" t
90504 - Bariatric - 32" w x 72" l x 3/16" t
90506 - Half - 23" w x 32" l x 3/16" t
90508 - Wall Storage Rack



WALL STORAGE RACK - Two 6" pegs are angled to keep the board from slipping. Mounting holes are vertically centered. Made of steel and painted white enamel. Shipping weight - 4 lbs (1.8 kgs)



PATIENT POSITIONING PRODUCTS

These products are used to provide comfortable positioning of the patient or to support a particular focal area of the body. Each item is available in either a standard or coated style.

Non-Coated Standard Gray Aids - Soft, open cell, polyurethane foam provides excellent support and comfort. This foam has minimal attenuation, is fire retardant and has been the industry standard for decades.

Coated Standard Aids - This is the same standard gray sponge, but is coated with a medical grade, durable and easy-to-clean vinyl surface that is resistant to blood, Betadine, barium, alcohol, oils and other fluids. Attenuation is very low (edges may show, depending on technique). Ideal for sterile environments.

Please note images are not to scale.

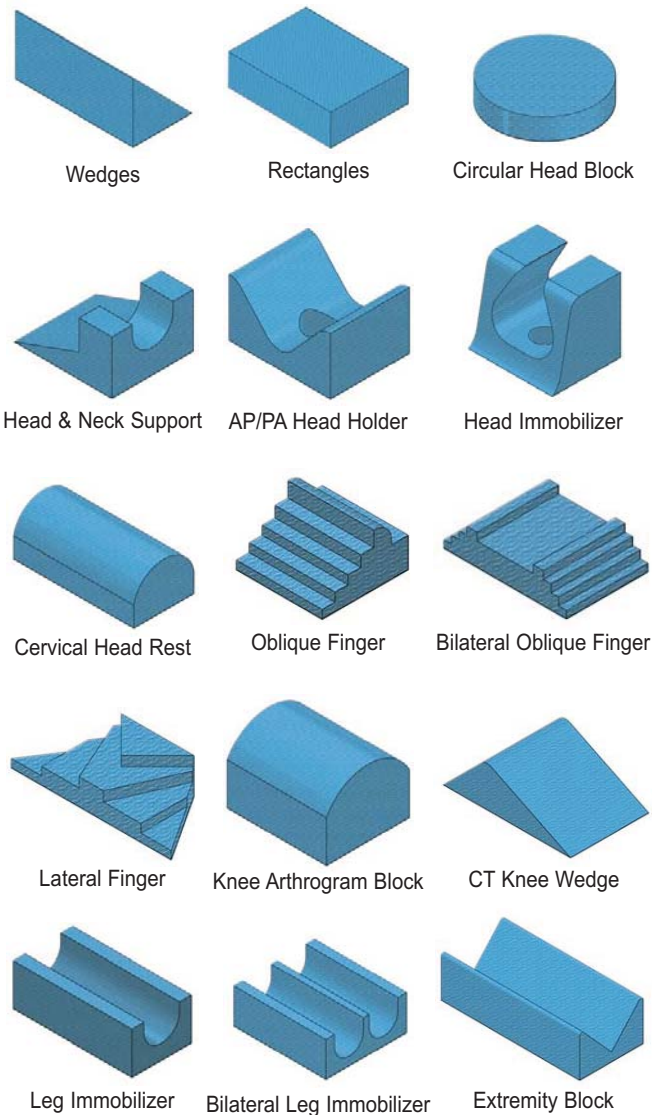

WEDGES			
Non-Coated	Coated	Description	Size
10114	10114-C	45° Spinal Wedge	7" x 21.5" x 7"
10123	10123-C	45° Wedge	7" x 14" x 7"
10078	10078-C	45° Wedge	7" x 7" x 7"
10100	10100-C	30°-60°-90° Wedge	10" x 24" x 6"
10116	10116-C	27° Wedge	10" x 10" x 6"
10098	10098-C	21° Wedge	10" x 10" x 4.63"
RECTANGLE			
Non-Coated	Coated	Description	Size
10070	10070-C	3" Rectangle	7.5" x 10" x 3"
10120	10120-C	3" Rectangle	14" x 18" x 3"
10102	10102-C	4" Rectangle	10" x 10" x 4"
10160	10160-C	0.5" Rectangle	1" x 3" x 0.5"
10046	10046-C	1" Rectangle	4" x 6" x 1"
10122	10122-C	1.5" Rectangle	4" x 6" x 1.5"
10123	10123-C	2" Rectangle	4" x 6" x 2"
10124	10124-C	Rectangle Mat (Set of 2)	18" x 24" x 0.25"
HEAD & NECK POSITIONING AIDS			
Non-Coated	Coated	Description	Size
10152	10152-C	Circular Head Block	7" x 1.5"
10104	10104-C	Head & Neck Support	12" x 10" x 6.5"
10044	10044-C	AP/PA Adult Head Holder	10" x 11" x 6.75"
10094	10094-C	AP/PA Pediatric Head Holder	7" x 9" x 5"
10240	10240-C	Adult Head Immobilizer	9" x 11" x 9.75"
10222	10222-C	Pediatric Head Immobilizer	6" x 9" x 7"
10106	10106-C	Cervical Head Rest	6" x 12" x 4.5"
EXTREMITY POSITIONING AIDS			
Non-Coated	Coated	Description	Size
10084	10084-C	Adult Oblique Finger Block	
10258	10258-C	Bilateral Adult Oblique Finger Block	
10214	10214-C	Bilateral Pediatric Oblique Finger Block	
10260	10260-C	Adult Lateral Finger Block	
10216	10216-C	Pediatric Lateral Finger Block	
10206	10206-C	Knee Arthrogram Block	10" x 12" x 8"
10194	10194-C	CT Knee Wedge Support	22" x 13.5" x 7"
10232	10232-C	Leg Immobilizer	10" x 20" x 7"
10220	10220-C	Bilateral Leg Immobilizer	14" x 16" x 6"
10136	10136-C	Small Extremity Block	3" x 4" x 10"
10134	10134-C	Medium Extremity Block	5" x 7" x 15"
10042	10042-C	Large Extremity Block	7" x 11" x 24"
10128	10128-C	Extra Large Extremity Block	9" x 11" x 36"

BODY CALIPER

Marked in inches and centimeters. This unit measure body thickness to be x-rayed. Made of durable aluminum. 1" w x 17 3/4" w x 10 1/2" d. ASW = 1 lbs (0.4 kgs)





PATIENT POSITIONING PRODUCTS



Myelogram Block



Angular Bolster

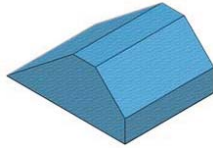

Bariatric Torso Bolster

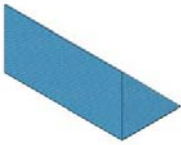

Bariatric Spinal Wedge



Bariatric Rectangle

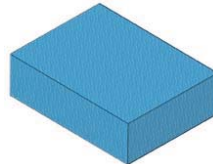

Decubitus Pad

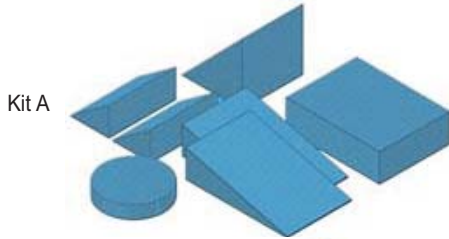

Kit A

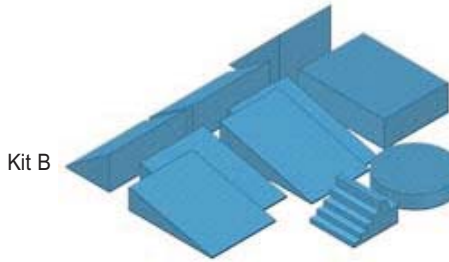

Kit B

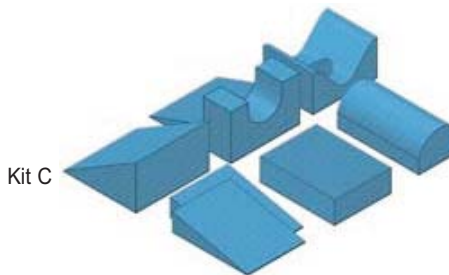

Kit C

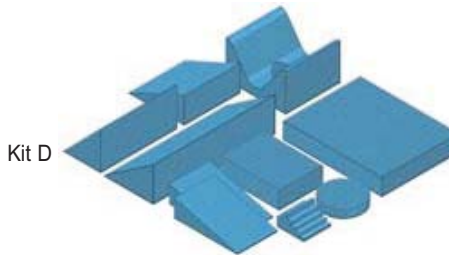

Kit D

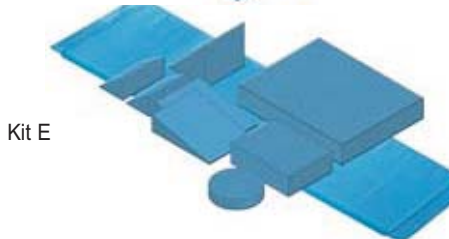

Kit E

BODY/TORSO POSITIONING AIDS

Non-Coated	Coated	Description	Size
10132	10132-C	Adult Myelogram Block	10" x 22" x 14"
10200	10200-C	Pediatric Myelogram Block	8" x 14" x 10"
10058	10058-C	Angular Bolster	12.5" x 16" x 7.25"

BARIATRIC POSITIONING AIDS

Non-Coated	Coated	Description	Size
10054	10054-C	Bariatric Torso Bolster	16" x 12" x 7"
10088	10088-C	Bariatric Spinal Wedge	7" x 21.25" x 7"
10192	10192-C	Bariatric Rectangle	8" x 12" x 3"
10224	10224-C	Decubitus Pad	18" x 24" x 4"

GENERAL POSITIONING AID KITS

Non-Coated	Coated	Description
Kit A		1 - Circular Head Block
10014	10014-C	1 - 45° Wedge - 7" x 7" x 7"
		2 - 34° Wedge - 14" x 7" x 3"
		2 - 15° Wedge - 11" x 7" x 3"
		1 - Rectangle - 7.25" x 10" x 3"
Kit B		1 - Adult Obl. Finger Block
10016	10016-C	1 - Circular Head Block
		1 - 45° Wedge - 7" x 7" x 7"
		2 - 34° Wedge - 14" x 7" x 3"
		2 - 15° Wedge - 11" x 7" x 3"
		2 - 12° Wedge - 9.5" x 7.25" x 2.25"
		1 - Rectangle - 7.25" x 10" x 3"
Kit C		1 - Head & Neck Support
10018	10018-C	1 - AP/PA Child Head Holder
		1 - Cervical head Rest
		1 - 27° Wedge - 10" x 10" x 6"
		2 - 12° Wedge - 9.5" x 7.25" x 2.25"
		1 - Rectangle - 7.25" x 10" x 3"
Kit D		1 - Adult Obl. Finger Block
10020	10020-C	1 - Circular Head Block
		1 - AP/PA Adult Head Holder
		1 - 45° Wedge - 7" x 7" x 7"
		1 - 21° Wedge - 10" x 10" x 4.63"
		2 - 15° Wedge - 11" x 7" x 3"
		1 - Rectangle - 7.25" x 10" x 3"
		1 - Rectangle - 14" x 18" x 3"
		1 - 27° Wedge - 10" x 10" x 6"
		1 - Multi-Angle Wedge
Kit E		1 - Circular Head Block
10022	10022-C	1 - 45° Wedge - 7" x 7" x 7"
		2 - 34° Wedge - 14" x 7" x 3"
		2 - 12° Wedge - 9.5" x 7.25" x 2.25"
		1 - Rectangle - 7.25" x 10" x 3"
		1 - Rectangle - 14" x 18" x 3"
		1 - Standard Table Pad



PATIENT INFORMATION SIGNS

All signs are constructed of 1/8" thick Trovicel. Double-faced tape is attached to the back of each sign for mounting. Large signs are 5" x 10", while the small signs are 4" x 10". The large MRI "Danger" signs are 12" x 18".



Model No. 90024R / 90024B



Model No. 90031



Model No. 90033

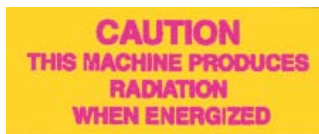

Model No. 90035



Model No. 90038R / 90038B



Model No. 90032R / 90032B



Model No. 90036R / 90036B

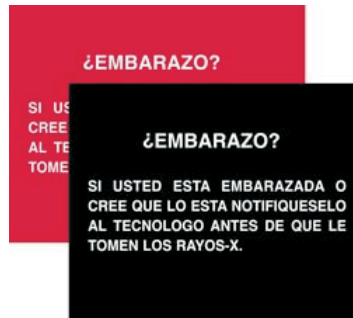

Model No. 90034R / 90034B



Model No. 90014R / 90014B



Model No. 90028R / 90028B



Model No. 90010R / 90010B



Model No. 90012R / 90012B



Model No. 90030R / 90030B



Model No. 90022R / 90022B

MRI WARNING SIGNS



Model No. 90040

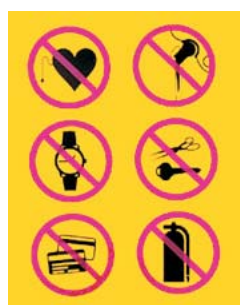

Model No. 90041

NEW - MRI Zone Signs - complies with ACR safe practice guidelines for identifying visible safeguards and boundaries to help protect patients, staff and anyone else near or within the MRI department.

Diagrams the four MRI ZONES in a generic format. Explains "who" is allowed and restricted "where" and how signs are posted.



Model No. 90042

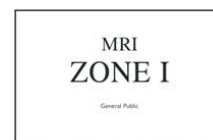

Model No. 90043



Model No. 90044

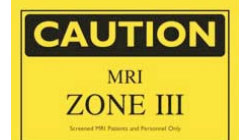

Model No. 90045



Model No. 90046



CASSETTE HOLDERS

A. Deluxe Mobile Cassette Holder This unit accepts cassettes from 5" x 7" through 14" x 51". Cassettes can be positioned in the Lower Cassette Assembly separately or with a grid, grid cassette or grid protector. Our unique design automatically adjusts to the various thicknesses of these combinations.

As an added feature, the lower cassette assembly can swivel up to 45° to the left or right. Additionally, the complete assembly will rotate 360° degrees around the support pole for weight bearing studies, lower extremity examinations and cross-table work. All height and swivel adjustments are made using a large, easy motion lever. Oversized locking wheels make transporting and positioning easy and precise. A low center of gravity gives added stability.

ASW = 50 lbs (22.5 kgs)

B. Cross Table Cassette Holder This Cross Table Cassette Holder features our adjustable cassette assembly that will accommodate any cassette and grid combination, grid cassette or grid protector from 7" to 17" wide.

ASW = 5 lbs (2.3 kgs)

C. Cassette Transfer Carts

Model 10930 - Why use a big general purpose cart when you can choose this highly maneuverable model designed specifically for cassettes? Our cart has two compartments that slope towards the rear, placing the weight of the cassettes over the back wheels and making the cart easy to steer. Holds up to 14 cassettes. ASW = 20 lbs (9.1 kgs)

Model 10940 - Need a larger cart? Our space saving carts have sturdy 4" casters with padded bar-style handles and scuff-resistant tops. Rubber corrugated mats line the inside of each compartment of this powder-coated, steel construction cart. Eight 6" wide compartments with 16 3/4" vertical clearance. Nominal size is 24"w x 18"d x 42 1/2"t. ASW = 120 lbs (54.5 kgs)

Model 10950 - NEW - EXTRA PROTECTION FOR CR CASSETTES - This cart has special impact-resistant padding on all shelves and vertical surfaces specifically to help prevent damage to expensive CR Cassettes. We use sturdy 4" casters with padded bar-style handles and scuff-resistant tops. Finish is powder-coated on this steel construction cart. Eight 6" wide compartments with 16 3/4" vertical clearance. Nominal size is 24"w x 18"d x 42 1/2"t. ASW = 120 lbs (54.5 kgs)



A. Model 10900



B. Model 10920



Model 10950



Model 10920



Model 10930



CLEARVUE™ GENERAL RADIOGRAPHY X-RAY FILMS

XOG, XRP & HSB - are designed for medical x-ray applications subject to a variety of processing conditions. The characteristics of ClearVue films provide consistent and reliable results under all conditions. ClearVue films are suitable for a wide range of general radiographic procedures with excellent detail throughout the diagnostic range. ClearVue films are coated on a blue polyester base, and exhibit excellent handling characteristics, long shelf life, low fog and high sharpness.

XOG film is a medium-speed, medium-high contrast orthochromatic film for use with blue/green emitting rare-earth intensifying screens. **XOGL** film is a medium-speed, wide-latitude orthochromatic film. **XRP** film is for all UV/blue-sensitive x-ray film. It provides excellent detail throughout the entire diagnostic range. **HSB** film is a fine grain, high contrast UV/blue-sensitive x-ray film.

Processing: ClearVue film is compatible with all reputable brand chemicals and is suitable for automatic or manual processing. The recommended temperature is 90-95° F depending on the processing cycle.

Packing: All types and sizes except the 14" x 36" sheets are packaged in boxes of 100 sheets, non-interleafed; 14" x 36" sheets are individually



CLEARVUE™ SPECIALTY X-RAY FILMS

Incorporate the latest developments in emulsion technology, resulting in the optimum combination of speed, sharpness and fine grain for maximum detail. **MRB/BRC** films are designed for CT, MRI, Ultrasound, Digital Radiography and Nuclear Medicine applications. **DUP** films are designed for duplication of general and specialty films.

MRB/BRC films are a high contrast, single emulsion, orthochromatic film designed for multi-imaging applications in CT, MRI, ultrasound, digital radiography, nuclear medicine and extremity radiographs.

DUP is a direct reversal film, designed to produce accurate copies of conventional radiographs and video images using either ultraviolet or white light.

FILM DUPLICATOR



Model 30794

This duplicator is built for medium volume usage. Simply place the original x-ray (up to 14" x 17") and the copy on the glass working surface, press "expose and then process" films. Even distribution of UL light using an adjustable timer. Comes complete with a set of spare bulbs.

Model:	30794
Dimensions:	18" w x 12" h x 15" d (46 x 37 x 38cm)
ASW:	31 lbs (14.1 kgs)
Finish:	Powder coat, beige
Construction:	Durable steel construction
Voltage:	110-120 V

DENTAL & VETERINARY X-RAY FILMS

ClearVue™ Dental Panoramic X-Ray Films



AMD also provides film for dental and veterinary professionals. All AMD film, no matter what market is produced to serve, is medical grade.

Dental and veterinary films are both produced in blue and green varieties. Duplicating film is also available. All standard film sizes are conveniently packaged in 100 sheet boxes. Cases contain five boxes. Order in either box or case lots.

ClearVue™ Veterinary Panoramic X-Ray Films



For all film sizes and package quantities, please go to www.digitalams.com .



CASSETTES

Deluxe Cassettes are constructed from highly durable lightweight aluminum and offer excellent resistance to shock, thereby enhancing cassette life. Employing a highly flexible cushioning material, the cassettes assure excellent film/screen contact. Models available include standard format, I.D. windows and with screens installed.

Sizes from 8" x 10" to 14" x 36" and 18 x 24 cm to 35 X 43 cm.

Grid Cassettes combine your grids and cassettes into one unit. Using your most popular grids in a Grid Cassette will significantly reduce examination set-up times and add protection to these costly tools.

Also available:

- Film carry cases and caddies
- More cassette holding products
- Disposable cassette covers



Value Point



Deluxe Cassette

SCREENS

AMD Rare-Earth Intensifying Screens*

AMD Green screens are primarily intended for use with orthochromatic or green sensitive x-ray film. These screens are recommended for all general radiographic procedures, providing an optimum mixture of dosage reduction and image quality. Green Fast-600 Speed, Green Regular-400 Speed, Green Medium-200 Speed, Green Fine-100 Speed.

AMD Blue is an ultra speed x-ray intensifying screen utilizing rare-earth phosphors. The rich blue components of the light output makes this screen particularly well suited for use with blue sensitive films. Blue III-800 Speed, Blue Fast Detail-400 Speed, Blue Detail-100 Speed, Blue Rapid-1,000 Speed.

AMD Calcium Tungstate These screens employ carefully controlled calcium tungstate phosphors which exhibit a more linear response over a broader kVp range. They are recommended for general radiography and provide a efficient balance of speed and image quality. Calcium High Plus-200 Speed, Calcium Medum-100 Speed, Calcium Detail-50 Speed,

*Metric and standard sizes available.



GRIDS

AMD X-Ray Grids contain the purest lead available to ensure superior efficiency in removing scattered radiation and leading to superlative clean up. Superior quality images are achieved through the use of finest lead strips and aluminum interspacers which are milled to precise uniformity.

Grid Strips are sealed between a smooth aluminum cover and finished in enamel, providing complete resistance to heat and moisture - guaranteed years of trouble-free service.

Grid Encasements seal your grid within High-impact Polycarbonate for maximum protection. Designed with extended edge for grid channels or flush mounted to fit over cassette. Edges are sealed and are available for all grid sizes.

Grid Caps protect your investment in costly grids. Constructed of two steel frames and a protective grid cover for durability. They are available in inch or centimeter sizes.





LET US CUSTOMIZE A PRODUCT FOR YOU

AMD Technologies stands ready to provide a custom product to meet your individual needs. You may submit a detailed plan drawing or just give us an idea of your product objective and cost target.

EXPORT MARKET

We are experienced in serving the international marketplace and are able to provide required international voltages and documentation.

TERMS & CONDITIONS:

Complete terms and conditions are available on our website or phone us to discuss any questions



218 Bronwood Avenue
Los Angeles, CA 90049-3104 USA
V/F: 800.423.3535 310.471.8900
E: info@digitalams.com
W: www.digitalams.com

Dealer Imprint